

SEPCO®

Sealing Equipment Products Co., Inc.



Quality Fluid Sealing Solutions for Industry.

Sealing Equipment Products Co., Inc.

SEPCO®

800-633-4770



SEALING EQUIPMENT PRODUCTS Co., Inc.

QUALITY FLUID SEALING SOLUTIONS FOR INDUSTRY.

SEALING EQUIPMENT PRODUCTS COMPANY, HEADQUARTERED IN ALABASTER, AL, IS A MANUFACTURER WITH A LONG STANDING TRADITION OF PROVIDING THE HIGHEST QUALITY FLUID SEALING PRODUCTS AVAILABLE IN THE MARKET PLACE. OUR PRIMARY FOCUS IS TO DELIVER EXCELLENT CUSTOMER SERVICE. WITH OVER 100 ASSOCIATES AND 120,000 SQUARE FEET OF MANUFACTURING SPACE IT IS ONE OF THE LARGEST FEMALE OWNED BUSINESSES IN THE SOUTHEAST.

MAJOR PRODUCT AND SERVICES

OUR PRODUCTS ARE USED IN A WIDE VARIETY OF PROBLEM SOLVING APPLICATIONS WORLD WIDE. THE PRODUCT LINE INCLUDES: COMPRESSION PUMP PACKING, DIE-FORMED AND CUT RINGS, GASKETS, GASKETING MATERIAL, FLEXIBLE GRAPHITE AND FIBERGLASS PRODUCTS INCLUDING FIRESLEEVEING. ONE OF THE COMPANIES FASTEST GROWING PRODUCT LINES IS MECHANICAL SEALS. WE ARE LEADING THE WAY IN INNOVATIVE DESIGNS THAT MAKE MECHANICAL SEAL REPAIR PROGRAMS OBSOLETE.

MARKETS

SEALING EQUIPMENT PRODUCTS COMPANY HAS AN EXTENSIVE NETWORK OF INDUSTRIAL DISTRIBUTORS WHO PROVIDE FLUID SEALING PRODUCTS TO ELECTRICAL UTILITIES, PULP AND PAPER MILLS, REFINERIES, WASTE WATER TREATMENT PLANTS, MINING OPERATIONS, CHEMICAL PROCESSING PLANTS AND OTHER PROCESS INDUSTRIES. IN ADDITION, THE COMPANY IS A CERTIFIED SUPPLIER TO PUMP AND VALVE MANUFACTURERS.

QUALITY

SEALING EQUIPMENT PRODUCTS COMPANY IS CERTIFIED TO ISO 9001: 2000 STANDARDS.

TABLE OF CONTENTS

STANDARD COMPONENT SEALS

CSO-CORROSIVE SERVICE OUTSIDE SEAL . . .	2
SRS-SHORT ROTARY SEAL	3
HDN-HEAVY DUTY NARROW SEAL	4

STANDARD CARTRIDGE SEALS

SRC-SINGLE ROTARY CARTRIDGE	5
VGS-VERSATILE GENERAL SERVICE	6
GEM-GENERAL SERVICE ECONOMICAL	7
DTP-DOUBLE TANDEM PUMPER	8
RBD-RECIPROCAL BALANCED DUPLEX	9

SPECIAL DUTY COMPONENT SEALS

TJS-THIN JUMBO SEAL	10
OMS-OUTSIDE MIXER SEAL	11
PDC-POSITIVE DISPLACEMENT COMPONENT	12
OSS-OUTSIDE SINGLE SPRING	13
SMD-SHAFT MOUNTED DOUBLE	14

SPECIAL DUTY CARTRIDGE SEALS

BSS-BALANCED SINGLE SPRING	15
PDS-POSITIVE DISPLACEMENT SINGLE . . .	16
HOS-HOT OIL SEAL	17
VSR-VERTICAL SINGLE ROTARY	18

ESC-EXTERNAL SINGLE CARTRIDGE	19
ESD-EXTERNALLY SET DOUBLE SEAL	20
PRO-PROGRESSIVE CAVITY PUMP SEAL . . .	21
DRC-DOUBLE ROTARY CARTRIDGE	22
RBA-RECIPROCAL BALANCED AXIAL	23
EDP-ETHANOL DOUBLE PUMPER	24
OUS-OVER UNDER SEAL	25

INSTALLED DIMENSIONS

CSO	26
HDN	27
SRS	28
BSS	29
GEM	30
HOS	31
SRC	32
VGS	33
DTP	34
RBD	35
SRC (BIG BORE)	36
DTP (BIG BORE)	36
STATIONARY SEATS	37

STYLE INDEX

BSS BALANCED SINGLE SPRING	15, 29
CSO CORROSIVE SERVICE	2, 26
DRC DOUBLE ROTARY CARTRIDGE	22
DTP DOUBLE TANDEM PUMPER	8, 34, 36
EDP ETHANOL DOUBLE PUMPER	24
ESC EXTERNAL SINGLE CARTRIDGE	19
ESD EXTERNALLY SET DOUBLE SEAL	20
GEM GENERAL SERVICE ECONOMICAL . . .	7, 30
HDN HEAVY DUTY	4, 27
HOS HOT OIL SEAL	17, 31
OMS OUTSIDE MIXER SEAL	11
OSS OUTSIDE SINGLE SPRING	13

OUS OVER UNDER SEAL	25
PDC POSITIVE DISPLACEMENT COMPONENT	12
PDS POSITIVE DISPLACEMENT SINGLE . . .	16
PRO PROGRESSIVE CAVITY PUMP SEAL . . .	21
RBA RECIPROCAL BALANCED AXIAL	23
RBD RECIPROCAL BALANCED DUPLEX . . .	9, 35
SMD SHAFT MOUNTED DOUBLE	14
SRC SINGLE ROTARY	5, 32, 36
SRS SHORT ROTARY	3, 28
TJS THIN JUMBO SEAL	10
VGS VERSATILE GENERAL SERVICE	6, 33
VSR VERTICAL SINGLE ROTARY	18

STANDARD COMPONENT SEALS

CSO - CORROSIVE SERVICE OUTSIDE SEAL

The SEPCO® CSO seal is a single rotating assembly designed for mounting externally. Since the metal components are isolated from the fluid, the seal can operate in highly corrosive applications without upgrading to expensive exotic alloys.

Hydraulically Balanced

The CSO is reverse-balanced to prevent catastrophic leakage from face separation caused by stuffing box pressure surges. Hydraulic load is reduced at elevated pressures resulting in cooler operation and long-term reliability.

Easily Installed and Maintained

Since the CSO mounts externally and has assembly clips to fix the axial setting, installation is easy with no installation measurements required. Inspection and adjustment are readily performed to insure correct spring loads are maintained.

Easily Serviced

Adjustments and cleaning are performed without removal and equipment disassembly.

Isolated Multiple Springs

Equally spaced multiple springs allow even loads and operate cooler than split collar designs. To prevent clogging and corrosion they are isolated from the process fluid and made from Hastelloy®

Field Repairable

Components subject to normal wear can be replaced in the field without the cost and inventory associated with factory repair while providing reliability consistent with new seals.



NOTES: 1. A clamp-in stationary seat must be specified and ordered separately. 2. A split ring option is available and should be used on fragile sleeve materials such as glass, fiberglass, ceramic, etc.

CSO - SPECIFICATIONS

Metal Parts:

Standard metal parts and set screws: 316 SS
Standard drive pins and springs: Hastelloy® C

Face Materials:

Standard: High quality chemical grade carbon-graphite*
Optional: Glass filled PTFE, ceramic, siliconized carbon*
*Metal banded to prevent mechanical breakage due to high torque

O-ring Materials:

Standard: Viton®, EPR, Aflas™
Optional: Perfluorinated Elastomers

Operating Capabilities:

Pressure: To 150 psig (10 bar g)
Temperature: -20° to 250°F (-29° to 121°C)
Speeds: 2600 fpm (13 m/s)

Viton® is a registered trademark of E.I. duPont.
Aflas™ is a trademark of Asahi Glass Co., Ltd.
Hastelloy® is a registered trademark of Haynes International, Inc.

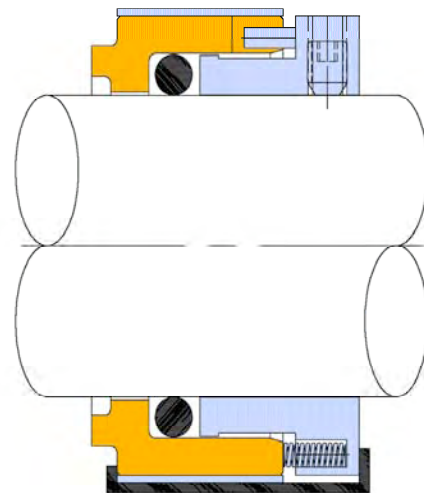

Stationary seat rings must be ordered separately.
Please see page 37 for standard configurations.

www.sepcoUSA.com

800-633-4770

SRS - SHORT ROTARY SEAL

The SEPCO® SRS is a single rotary unit designed for mounting internally and for general service operation on lubricating process fluids where 316SS is compatible. Several mating ring configurations and materials are available for running in conjunction with the SRS and must be specified and ordered separately.

Compact Design

The small cross-section design and short operating height permit use in all types of seal chambers without modification. SRS rotary units are designed to operate at a common axial setting of 1.375".

Hydraulically Balanced

Positive hydraulic balancing permits use in higher pressures by reducing closing loads resulting in cooler operation and extended reliability. The balance feature also reduces power consumption.

Resists Clogging

The placement of the dynamic o-ring allows it to move toward a clean surface as the seal faces wear. This allows for use on process liquids that contain suspended solids.

Isolated Multiple Springs

The multiple spring design allows for even mechanical loads and cooler operation. To prevent clogging from suspended solids, the springs are isolated from the process fluid.

Static Shaft O-ring

The o-ring that seals to the shaft / sleeve does not slide axially as the seal adjusts for misalignment. This prevents fretting and eliminates the need to replace expensive shafts and sleeves.

Inexpensive

The simple design reduces cost while maintaining the integrity required to provide long, trouble-free operation.



SRS - SPECIFICATIONS

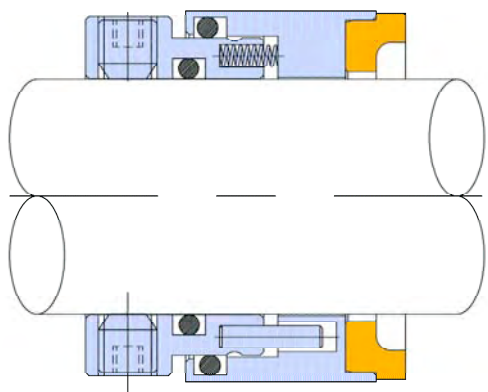

Stationary seat rings must be ordered separately.
Please see page 37 for standard configurations.

Metal Parts:

Standard metal parts, set screws and drive pins: 316 SS
Standard springs: Hastelloy® C

Face Materials:

Standard: High quality chemical grade carbon-graphite
Optional: Solid nickel bound tungsten carbide

O-ring Materials:

Standard: Viton®, EPR and Aflas™
Optional: Perfluorinated Elastomers

Operating Capabilities:

Pressure: To 350 psig (24 bar g)
Temperature: -20° to 400°F (-29° to 205°C)
Speeds: 5000 fpm (25 m/s)

HDN - HEAVY DUTY NARROW SEAL

The SEPCO® HDN is a single, component, rotary unit designed to mount internally. Rotaries equipped with carbon faces are for use on clean liquids and siliconized carbon faces are preferred for sealing slurries. Several mating ring configurations and materials are available for running in conjunction with the HDN and must be specified and ordered separately.

Narrow Design

The small cross-section permits installation in stuffing boxes with minimal radial clearance.

Hydraulically Balanced

Internal balancing reduces power consumption and permits use in higher pressures by reducing closing loads that result in cooler operation and extended reliability.

Isolated Multiple Springs

Multiple springs provide even mechanical loads for cooler operation. To prevent clogging and corrosion they are isolated from the process fluid and manufactured from Hastelloy®.

Static Shaft O-Ring

The o-ring that seals to the shaft/sleeve does not slide axially as the seal adjusts for misalignment preventing fretting and eliminating the need to replace expensive shafts and sleeves.

Field Repairable

Components that wear during normal operation can be easily replaced in-the-field for a fraction of the cost of a new seal. This reduces inventory while providing performance consistent with a new seal. The repair kit feature also makes the HDN attractive for applications that require the use of expensive alloys.



HDN - SPECIFICATIONS

Metal Parts:

Standard metal parts and set screws: 316 SS
Standard springs and drive pins: Hastelloy® C

Face Materials:

Standard: High quality chemical grade carbon-graphite and siliconized carbon
Optional: Solid nickel bound tungsten carbide

O-ring Materials:

Standard: Viton®, EPR and Aflas™
Optional: Perfluorinated Elastomers

Operating Capabilities:

Pressure: To 350 psig (24 bar g)
Temperature: -20° to 400°F (-29° to 205°C)
Speeds: 5000 fpm (25 m/s)

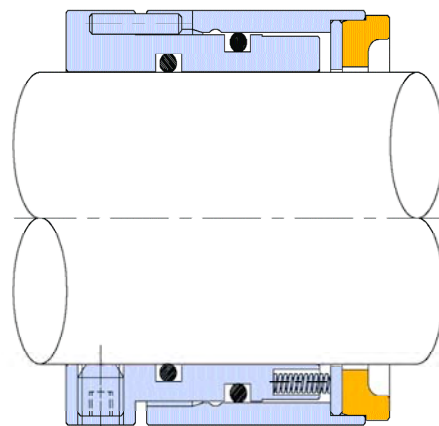

Stationary seat rings must be ordered separately.
Please see page 37 for standard configurations.

STANDARD SINGLE CARTRIDGE SEALS

SRC - SINGLE ROTARY CARTRIDGE SEAL

The SEPCO® SRC is a single internal cartridge-mounted rotary seal. The design is simple and loaded with design features found in more expensive seals. It is rugged and highly dependable yet cost less than most competitors' repaired units. It is designed for general service and for sealing lubricating liquids in pulp & paper, chemical processing, and wastewater treatment plants.

Cartridge Mounted

A completely self-contained unit pre-assembled and pre-set at the factory for ease of installation and maintenance on equipment where axial adjustments are required.

Compact

The small cross-section and short internal and external axial lengths allow for installation on equipment with small, shallow stuffing boxes as well as limited first obstruction space.

Versatile

The slotted gland allows the seal to fit a variety of stud sizes and bolt circle diameters. It is machined for superior strength and corrosion resistance and can be easily modified for fitting restricted spaces where equipment modifications are usually required.

Hydraulically Balanced

Hydraulic balancing is achieved internally and provides for operations at higher stuffing box pressures. The balance feature also allows the seal to load lighter and run cooler extending reliability and reducing power consumption.

Isolated Multiple Springs

The multiple springs provide even mechanical loads for cooler operation and are isolated to prevent clogging from process fluids containing suspended solids.



SRC- SPECIFICATIONS

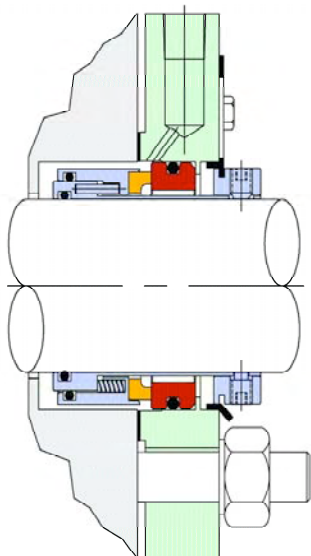

Metal Parts:

Standard metal parts and set screws: 316 SS
Standard springs and drive pins: Hastelloy® C

Face Materials:

Standard: High quality chemical grade carbon-graphite and silicon carbide
Optional: Solid nickel bound tungsten carbide

O-ring Materials:

Standard: Viton®, EPR and Aflas™
Optional: Perfluorinated Elastomers

Operating Capabilities:

Pressure: To 350 psig (24 bar g)
Temperature: -20° to 400°F (-29° to 205°C)
Speeds: 5000 fpm (25 m/s)

STANDARD SINGLE CARTRIDGE SEALS

VGS - VERSATILE GENERAL SERVICE SEAL

The springs in the **VGS** are located in the seal gland and are not subjected to centrifugal forces permitting operation on high PV applications. The stationary design eliminates seal face misalignment and is ideal in pulp & paper, chemical processing, wastewater treatment, and wherever high speed applications are found.

Stationary Design

The seal faces are squared 90° to the centerline of the shaft preventing misalignment and allowing for better control of the parallel sealing gap eliminating axial adjustments that cause wear.

Cartridge-Mounted

A completely self-contained unit pre-assembled and pre-set at the factory for ease of installation.

Compact

The narrow cross-section allows for installation on stuffing boxes with minimal radial space without requiring modifications. This includes small ANSI pumps with 5/16" radial space.

Versatile

The seal gland is slotted to provide versatility for mounting and machined for superior strength and corrosion resistance.

Hydraulically Balanced

Internal balancing provides for operation in higher pressures and reduces hydraulic loads providing for cooler operation and extended reliability. The balance feature also reduces power consumption.

Isolated Multiple Springs

Multiple springs provide even mechanical loads for cooler operation and are isolated to prevent clogging from process fluids containing suspended solids.



www.sepcoUSA.com

VGS - SPECIFICATIONS

Metal Parts:

Standard metal parts and set screws: 316 SS
Standard springs: Hastelloy® C

Face Materials:

Standard: High quality chemical grade carbon-graphite, solid nickel bound tungsten carbide, silicon carbide, and ceramic

O-ring Materials:

Standard: Viton®, EPR and Aflas™
Optional: Perfluorinated Elastomers

Operating Capabilities:

Pressure: To 350 psig (24 bar g)
Temperature: 32° to 400°F (0° to 205°C)
Speeds: 7500 fpm (38 m/s)

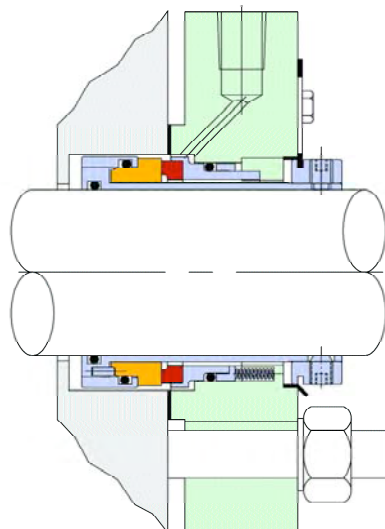

800-633-4770

STANDARD SINGLE CARTRIDGE SEALS

GEM - GENERAL SERVICE ECONOMICAL MODEL SEAL

The springs in the **GEM** are located in the seal gland and not subjected to centrifugal forces permitting this low-cost general service unit to operate on high PV factors. The cast gland reduces the cost of the seal and is ideal for installation on ANSI process pumps in pulp & paper, chemical processing, wastewater treatment, and wherever high speed applications are encountered

Stationary Design

The seal faces are squared 90° to the centerline of the shaft preventing misalignment and allowing for better control of the parallel sealing gap eliminating axial adjustments that cause wear.

Cartridge-Mounted

A completely self-contained unit pre-assembled and pre-set at the factory for ease of installation.

Compact

The narrow cross-section allows for installation on stuffing boxes with minimal radial space without requiring modifications. This includes small ANSI pumps with 5/16" radial space.

Versatile

The slotted gland plate design allows the seal to fit a variety of stud and bolt circle diameters.

Hydraulically Balanced

Internal balancing provides for operation in higher pressures and reduces hydraulic loads resulting in cooler operation and extended reliability. This balance reduces power consumption.

Isolated Multiple Springs

Multiple springs provide even mechanical loads for cooler operation and are isolated to prevent clogging from process fluids containing suspended solids.



GEM - SPECIFICATIONS

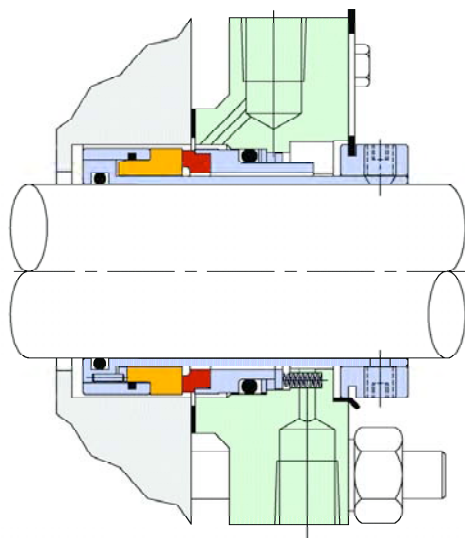

Metal Parts:

Standard metal parts and set screws: 316 SS
Standard springs: Hastelloy® C

Face Materials:

Standard: High quality chemical grade carbon-graphite, solid nickel bound tungsten carbide, silicon carbide, and ceramic

O-ring Materials:

Standard: Viton®, EPR and Aflas™
Optional: Perfluorinated Elastomers

Operating Capabilities:

Pressure: To 350 psig (24 bar g)
Temperature: 32° to 400°F (0° to 205°C)
Speeds: 7500 fpm (38 m/s)

STANDARD DOUBLE CARTRIDGE SEALS

DTP - DOUBLE TANDEM PUMPER SEAL

The SEPCO® DTP is a multiple cartridge mounted seal design that is simple, rugged, and highly dependable yet cost less than most competitors' comparable repaired seals. It is suitable in all types of industries where leakage of hazardous or costly products cannot be tolerated and where positive lubrication is required from an external source without dilution of the pumped product.

Cartridge Mounted

The DTP is a completely self contained unit pre-assembled and pre-set at the factory for ease of installation and maintenance on equipment where axial adjustments are required.

Reciprocal Balanced

The inboard seal is hydraulically balanced to permit the seal to operate in either a double or tandem mode. This allows lubrication to the inboard seal faces without separation and leakage.

Pumping Ring with Tangential Drilled Flush Connections

This feature allows the DTP to remove destructive frictional heat from the double seal cavity for cooler operation and extended reliability and makes it ideal for use on closed-loop flush systems.

Clamped-In Mating Rings

The stationary seats are clamped in allowing for higher pressure conditions and are exposed to the flow of flush liquid aiding in heat transfer and cooler operation.

Versatile

The seal gland is slotted to provide versatility in mounting and machined for superior strength and corrosion resistance. Flush connections are located to facilitate piping from the side without trapping air in the double seal cavity and causing excessive frictional heat and rapid face wear.



www.sepcoUSA.com

DTP - SPECIFICATIONS

Metal Parts:

Standard metal parts: 316 SS

Optional: Alloy 20, titanium, Hastelloy®, and low expansion alloys

Face Materials:

Standard: High quality chemical grade carbon-graphite and silicon carbide

Optional: Solid nickel bound tungsten carbide.

O-ring Materials:

Standard: Viton®, EPR and Aflas™

Optional: Perfluorinated Elastomers

Operating Capabilities:

Pressure: Inboard Seal: 350 psig (24 bar g) Pressure Differential

Outboard Seal: To 150 psig (10 bar g)

Temperature: Inboard Seal: To 400°F (205°C)

Outboard Seal: To 250°F (121°C)

Speeds: 5000 fpm (25 m/s)

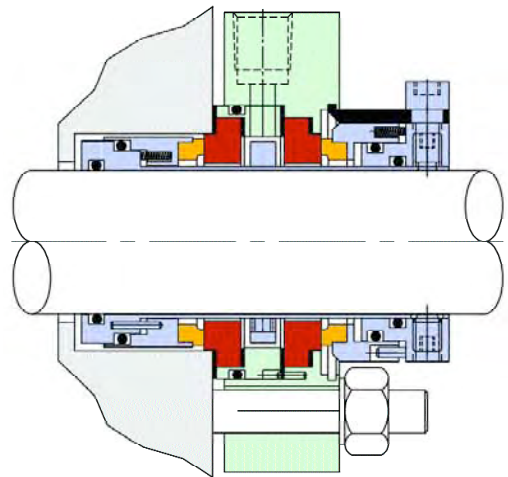

800-633-4770

STANDARD DOUBLE CARTRIDGE SEALS

RBD - RECIPROCAL BALANCED DUPLEX SEAL

The SEPCO® RBD is a multiple cartridge mounted seal with springs mounted in the gland to reduce centrifugal forces and permit operation on high PV applications. The RBD is used where leakage of hazardous or costly products cannot be tolerated and where positive lubrication without product dilution is required.

Stationary Design

This design squares the seal faces 90° to the centerline of the shaft preventing misalignment, giving better control of the parallel sealing gap and eliminating wear in secondary seal areas.

Cartridge Mounted

The RBD is a completely self-contained unit pre-assembled and pre-set at the factory for ease of installation and maintenance on equipment where axial adjustments may be required.

Versatile

The seal gland is slotted to provide versatility for mounting and machined for superior strength and corrosion resistance. The narrow cross-section inboard design allows for installation on stuffing boxes with minimal radial space.

Reciprocal Balanced

The inboard seal is balanced from both the product side as well as the flush side of the inboard seal faces. The seal can operate in either a tandem or double mode without face separation.

Multiple Springs

Multiple springs provide even mechanical loads for cooler operation and are isolated from the pumped product to prevent clogging. They are manufactured from Hastelloy® to provide superior corrosion resistance.



RBD - SPECIFICATIONS

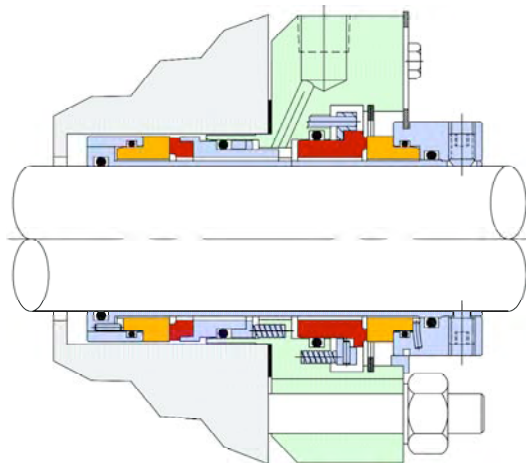

Metal Parts:

Standard metal parts and set screws: 316 SS
Springs: Hastelloy® C

Face Materials:

Standard: High quality chemical grade carbon-graphite, solid nickel bound tungsten carbide, ceramic, and silicon carbide

O-ring Materials:

Standard: Viton®, EPR and Aflas™
Optional: Perfluorinated Elastomers

Operating Capabilities:

Pressure: Inboard Seal: 350 psig (24 bar g) Pressure Differential
Outboard Seal: To 150 psig (10 bar g)
Temperature: Inboard Seal: To 400°F (205°C)
Outboard Seal: To 250°F (121°C)
Speeds: 7500 fpm (38 m/s)

SPECIAL DUTY SEALS - SINGLE COMPONENT

TJS - THIN JUMBO SEAL

The SEPCO® TJS is a single rotary unit designed to mount internally on large rotating equipment. It is ideal for use on pressure screens and other types of equipment where a component seal design is required. Several mating ring types and materials are available for running in conjunction with the TJS.

Compact Design

The narrow cross-section and compact working length allows use in all types of seal chambers without requiring modifications.

Hydraulically Balanced

The internal balance feature reduces power consumption and permits use in higher pressures without expensive stepped sleeves. It also reduces hydraulic loads for cooler operation.

Resists Clogging

The design of the dynamic o-ring allows it to move toward a clean surface to compensate for seal face wear allowing installation on lubricating process liquids that contain suspended solids.

Isolated Multiple Springs

Multiple springs provide even mechanical loads for cooler operation. To prevent clogging the springs are isolated from the process fluid and made from Hastelloy to resist corrosion.

Static Shaft O-Ring

The o-ring that seals to the shaft / sleeve does not slide axially along the shaft as the unit adjusts for misalignment. This prevents fretting and eliminates shaft and sleeve replacement.

Field Repairable

Primary and secondary seal components can be easily replaced in-the-field for a fraction of the cost of a new seal reducing inventories and providing performance of a repaired TJS consistent to that of a new one.

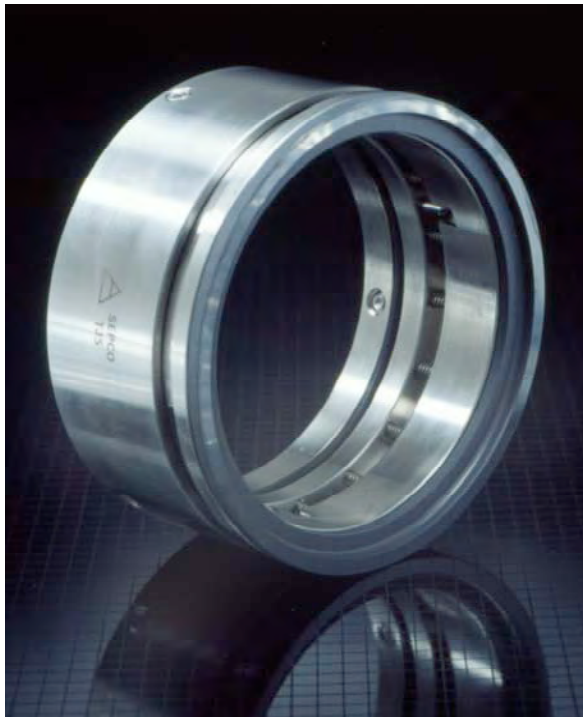

www.sepcoUSA.com

TJS - SPECIFICATIONS

Metal Parts:

Standard metal parts and set screws: 316 SS
Standard springs and drive pins: Hastelloy® C

Face Materials:

Standard: High quality chemical grade carbon-graphite
Optional: Solid nickel bound tungsten carbide

O-ring Materials:

Standard: Viton®, EPR and Aflas™
Optional: Perfluorinated Elastomers

Operating Capabilities:

Pressure: 350 psig (24 bar g)
Temperature: -20 to 400°F (-29° to 205°C)
Speeds: 5000 fpm (25 m/s)

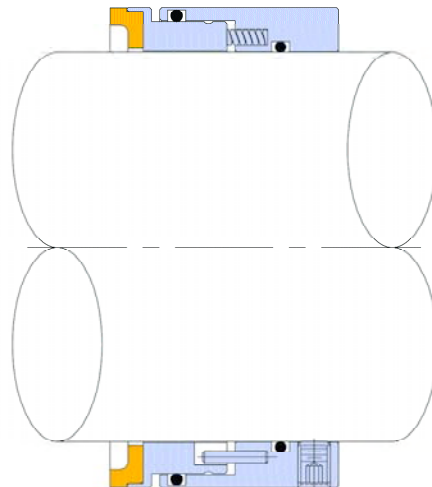

Stationary seat rings must be ordered separately.
Please see page 37 for standard configurations.

800-633-4770

SPECIAL DUTY SEALS - SINGLE COMPONENT

OMS - OUTSIDE MIXER SEAL

The SEPCO® OMS is an externally mounted single component seal capable of handling up to 1/4" shaft deflection. This makes it ideal for use on augers, belt driven pumps, mixers, agitators and slow moving rotating equipment with high rates of shaft deflection. The OMS is equipped with multiple springs that provide even mechanical loads reducing wear and extending performance.

Hydraulically Balanced

The OMS is reverse-balanced to prevent catastrophic leakage from face separation caused by stuffing box pressure surges. Hydraulic load is reduced at elevated pressures resulting in cooler operation and long-term reliability.

Easily Installed and Maintained

Since the OMS mounts externally and has assembly clips to fix the axial setting, installation is easy with no installation measurements required. Inspection and adjustment are readily performed to insure correct spring loads are maintained.

Easily Serviced

Adjustments and cleaning are performed without removal and equipment disassembly.

Field Repairable

Components subject to normal wear can be replaced in the field without the cost and inventory associated with factory repair while providing reliability consistent with new seals.

Static Shaft O-Ring

The o-ring that seals to the shaft is static and not required to slide axially along the shaft to accommodate for seal face misalignment. This prevents fretting and eliminates the need to replace expensive shafts and sleeves.

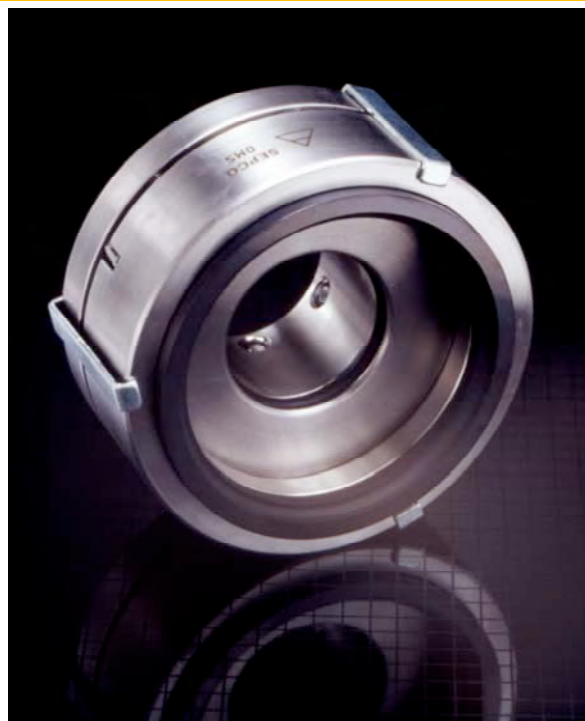

OMS - SPECIFICATIONS

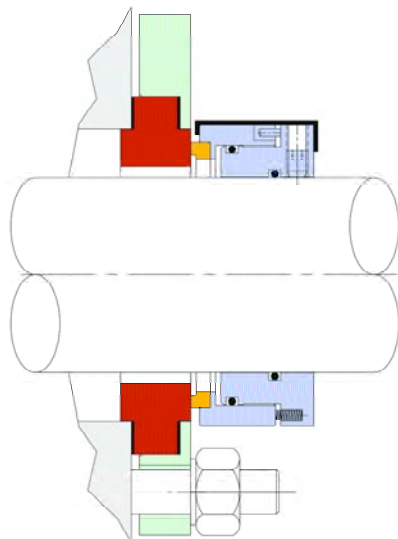

Stationary seat rings must be ordered separately.
Please see page 37 for standard configurations.

Metal Parts:

Standard metal parts and set screws: 316 SS
Standard springs and drive pins: Hastelloy® C

Face Materials:

Standard: High quality chemical grade carbon-graphite and solid nickel bound tungsten carbide
Optional: Silicon carbide

O-ring Materials:

Standard: Viton®, EPR and Aflas™
Optional: Perfluorinated Elastomers

Operating Capabilities:

Pressure: To 150 psig (10 bar g)
Temperature: -20° to 250°F (-29° to 121°C)
Speeds: 1000 fpm (5 m/s)

SPECIAL DUTY SEALS - SINGLE COMPONENT

PDC - POSITIVE DISPLACEMENT COMPONENT

The SEPCO® PDC is a single, internal component seal designed for positive displacement pumps, equipped with seal only stuffing boxes, moving highly viscous, abrasive and sticky fluids. Isolated multiple springs will not clog from suspended solids in the pumped product and will provide even mechanical loads. The simple yet rugged design is highly dependable and inexpensive.

Compact

The short operating height allows installation on equipment with limited axial space in the stuffing box.

O-Ring Design

Use of o-rings as secondary seals allows for installation on products that are highly corrosive to standard elastomers where PTFE secondary seals are normally required.

Rugged

Rotation is achieved with lugs and three strategically located knurl point hardened steel set screws that provide positive drive on applications where high torque conditions are encountered.

Internally Balanced

Balance is achieved internally to provide controlled hydraulic loads.

Static Secondary Seal

The shaft o-ring is not required to move axially to adjust for seal face misalignment preventing fretting and wear that requires replacement of expensive shafts.

High Torque Stationary Seat

The stationary seat is designed to reduce the possibility of spinning and mechanical breakage on products that are sticky.



www.sepcoUSA.com

PDC - SPECIFICATIONS

Metal Parts:

Standard metal parts: 316 SS
Standard springs: Hastelloy® C

Face Materials:

Standard: High quality chemical grade carbon-graphite or solid nickel bound tungsten carbide
Optional: Silicon carbide or 17-4PH stainless steel

O-ring Materials:

Standard: Viton®, EPR and Aflas™
Optional: Perfluorinated Elastomers

Operating Capabilities:

Pressure: To 350 psig (24 bar g)
Temperature: To 400°F. (205°C)

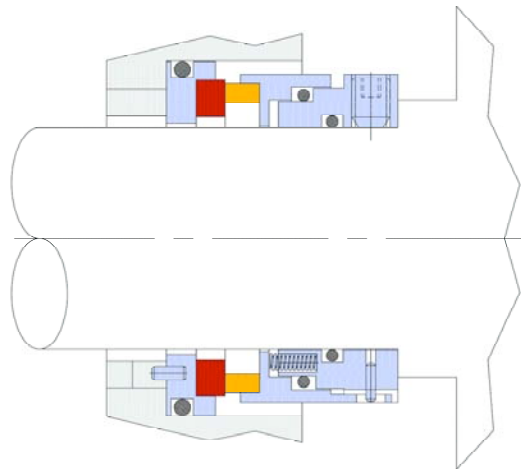

800-633-4770

SPECIAL DUTY SEALS - SINGLE COMPONENT

OSS - OUTSIDE SINGLE SPRING

The SEPCO® OSS is an external mounted, single spring component seal designed primarily for installation on positive displacement pumps. Ease of installation and maintenance makes the seal excellent for sealing products that polymerize. The OSS can be designed to handle up to 1/4" shaft deflection and 1/8" end-play making it also ideal for installation on augers, mixers, agitators and reactors.

Hydraulically Balanced

The OSS is reverse-balanced to prevent catastrophic leakage from face separation caused by stuffing box pressure surges. Hydraulic load is reduced at elevated pressures resulting in cooler operation and long-term reliability.

Easily Installed and Maintained

Since the OSS mounts externally and has assembly clips to fix the axial setting, installation is easy with no installation measurements required. Inspection and adjustment are readily performed to insure correct spring loads are maintained.

Easily Serviced

Adjustments and cleaning are performed without removal and equipment disassembly.

Field Repairable

Components subject to normal wear can be replaced in the field without the cost and inventory associated with factory repair while providing reliability consistent with new seals.

Static Shaft O-Ring

The o-ring that seals to the shaft is static and is not required to slide axially along the shaft to accommodate for seal face misalignment. This prevents fretting and eliminates the need to replace expensive shafts and sleeves.



OSS - SPECIFICATIONS

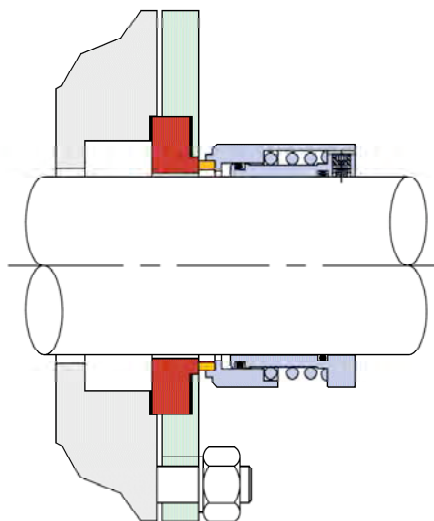

Stationary seat rings must be ordered separately.
Please see page 37 for standard configurations.

Metal Parts:

Standard metal parts and set screws: 316 SS

Face Materials:

Standard: High quality chemical grade carbon-graphite and solid nickel bound tungsten carbide
Optional: Silicon carbide

O-ring Materials:

Standard: Viton®, EPR and Aflas™
Optional: Perfluorinated Elastomers

Operating Capabilities:

Pressure: To 150 psig (10 bar g)
Temperature: -20° to 250°F (-29° to 121°C)
Speeds: 1000 fpm (5 m/s)

SPECIAL DUTY SEALS - DOUBLE COMPONENT

SMD - SHAFT MOUNTED DOUBLE SEAL

The SEPCO® SMD is a heavy duty multiple component seal that mounts externally on equipment with adequate first obstruction space. It can be designed to handle up to 1/4" shaft deflection and 1/8" end-play making it ideal for use on agitators, mixers, reactors, belt driven pumps and other equipment that exceeds the movement capabilities of standard off-the-shelf seal designs.

Hydraulically Balanced

Reciprocally balancing the seal allows for changes in operating pressure conditions without face separation. Reduced hydraulic loads allow the seal to operate successfully at high pressure without reducing lubrication critical for cooler operation & reliability.

Mounting

The seal mounts externally and the component design can be installed without making critical measurements. It is also available as a cartridge mounted unit where preferred.

Multiple Seal Design

Allows for installation on high-pressure applications where hazardous, abrasive, non-lubricating products are handled that requires flushing without dilution of the pumped product. The seal is capable of operating in either a double or tandem mode.

Isolated Metal Parts

The SMD can be designed to eliminate all metal components from the process fluid making it ideal for use on corrosive applications.

Lug Driven

The rotating elements are lug driven to provide positive rotation on high pressure or applications where torque factors are excessive.



www.sepcoUSA.com

SMD - SPECIFICATIONS

Metal Parts:

Standard metal parts: 316 SS

Face Materials:

Standard: High quality chemical grade carbon-graphite or solid nickel bound tungsten carbide
Optional: Silicon carbide

O-ring Materials:

Standard: Viton®, EPR and Aflas™
Optional: Perfluorinated Elastomers

Operating Capabilities:

Pressure: To 750 psig (52 bar g)
Temperature: -20° to 500°F. (-29° to 260°C)
Speeds: 5000 fpm (25 m/s)

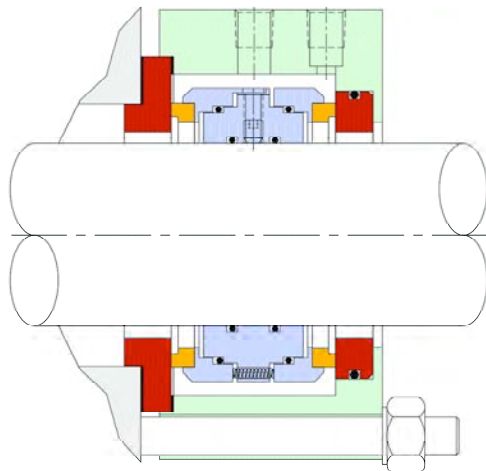

Stationary seat rings must be ordered separately.
Please see page 37 for standard configurations.

800-633-4770

SPECIAL DUTY SEALS - SINGLE CARTRIDGE

BSS - BALANCED SINGLE SPRING SEAL

The SEPCO® BSS is a single, internal, cartridge-mounted seal that utilizes a single coil spring for providing consistent mechanical loads to maintain seal face alignment. This permits the BSS to operate on equipment with up to 1/8" end play making it ideal for use on double suction pumps handling relatively clean liquids.

Cartridge Mounted

A completely self-contained unit pre-assembled and pre-set at the factory for ease of installation and maintenance.

Hydraulically Balanced

Internal balancing allows higher operating pressures than conventional unbalanced single spring designs. This feature reduces hydraulic loads for cooler operation and less power consumption.

Versatile

The small cross-section allows for installation on stuffing boxes with minimal radial space. The short external length permits installation on equipment with limited first obstruction space. The machined gland has superior strength and corrosion resistance. Modifications can be made to the seal rather than the equipment.

Static Shaft O-Ring

The o-ring that seals to the shaft / sleeve does not slide axially along the shaft preventing fretting and eliminating the need to replace expensive shafts and sleeves.

Field Repairable

Primary and secondary seal components that wear during normal operation can be easily replaced with new parts at a fraction of the cost of a new seal. This reduces inventory cost while providing performance consistent with new mechanical seals.



BSS - SPECIFICATIONS

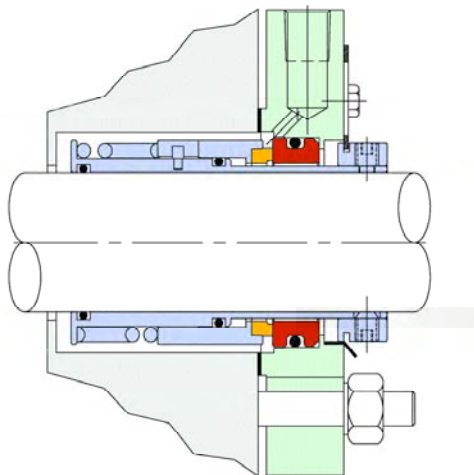

Metal Parts:

Standard metal parts and spring: 316 SS

Face Materials:

Standard: High quality chemical grade carbon-graphite, solid nickel bound tungsten carbide, and silicon carbide

Optional: 17-4PH

O-ring Materials:

Standard: Viton®, EPR and Aflas™

Optional: Perfluorinated Elastomers

Operating Capabilities:

Pressure: To 300 psig (21 bar g)

Temperature: -20° to 400°F (-29° to 205°C)

Speeds: 5000 fpm (25 m/s)

SPECIAL DUTY SEALS - SINGLE CARTRIDGE

PDS - POSITIVE DISPLACEMENT SINGLE SEAL

The SEPCO® PDS mounts externally and is a single, cartridge mounted, rotary seal designed for positive displacement pumps where viscous, abrasive, and sticky products are encountered.

Custom Built

The seal gland can be designed to fit equipment that normally requires modifications in order to fit a cartridge mounted seal. The machined gland offers excellent corrosion resistance and strength.

Rugged Design

The PDS is simple yet highly dependable. Drive mechanisms provide positive start up where high torque conditions are encountered.

Cartridge Mounted

The unit is pre-assembled and pre-set at the factory for ease of installation and maintenance.

Reverse Balanced

The PDS is balanced to prevent face separation during extreme pressure surges.

Compact

The unit mounts externally and the short axial length makes it ideal for fitting equipment with limited first obstruction space.

Isolated Multiple Springs

Multiple springs provide even mechanical loads and are isolated from the pumped product to prevent clogging.

Inexpensive

The simple design makes the PDS an inexpensive alternative for sealing positive displacement pumps. The unit is also fully repairable for a fraction of the cost of a new seal.

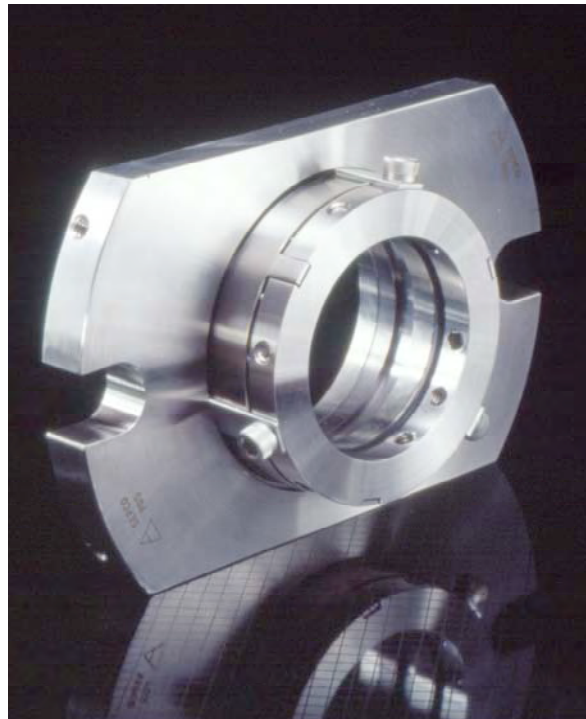

www.sepcoUSA.com

PDS - SPECIFICATIONS

Metal Parts:

Standard metal parts and spring: 316 SS

Face Materials:

Standard: High quality chemical grade carbon-graphite and solid nickel bound tungsten carbide

Optional: Silicon carbide and 17-4PH stainless steel

O-ring Materials:

Standard: Viton®, EPR and Aflas™

Optional: Perfluorinated Elastomers

Operating Capabilities:

Pressure: To 150 psig (10 bar g) with surges to 300 psig (21 bar g)

Temperature: -20° to 250°F (-29° to 121°C)

Speeds: 2600 fpm (13 m/s)

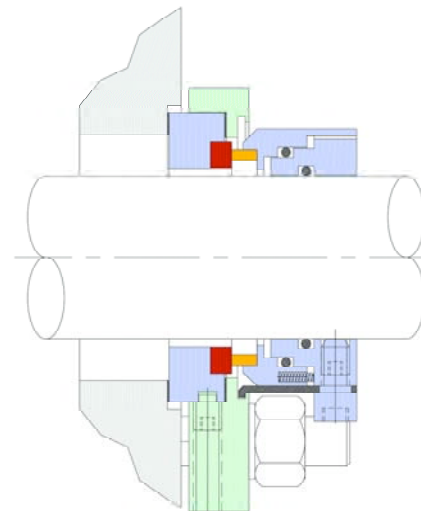

800-633-4770

SPECIAL DUTY SEALS - SINGLE CARTRIDGE

HOS - HOT OIL SEAL

The **HOS** is a balanced, single spring, rotary seal capable of handling conditions much higher than conventional single spring designs. It was developed for use where lubricating products are handled that contain suspended solids as well as thermosensitive liquids that set up and harden at ambient temperatures.

Non-Clogging

The design of the HOS allows operation in liquids that contain suspended solids or thermosensitive products that have a tendency to impede operation as wear occurs.

Single Coil Spring

This spring keeps a consistent load as the faces wear and is more resistant to clogging than other types of loading devices.

Cartridge Mounted

This completely self-contained unit is pre-assembled and pre-set at the factory for ease of installation and maintenance on equipment that requires periodic axial adjustments.

Hydraulically Balanced

Hydraulic balancing is achieved internally allowing operation at high pressures. This also reduces hydraulic loads resulting in cooler operation, less power usage and extended reliability.

Turbulence Enhancer

The compression ring is designed to create movement in and around the dynamic o-ring reducing accumulation of solids. This allows correct seal face alignment.

Versatile

The HOS is available for standard and oversized stuffing boxes. The slotted gland allows for versatility in mounting the seal. Machined parts provide superior corrosion resistance and eliminate expensive modifications to the equipment.



HOS - SPECIFICATIONS

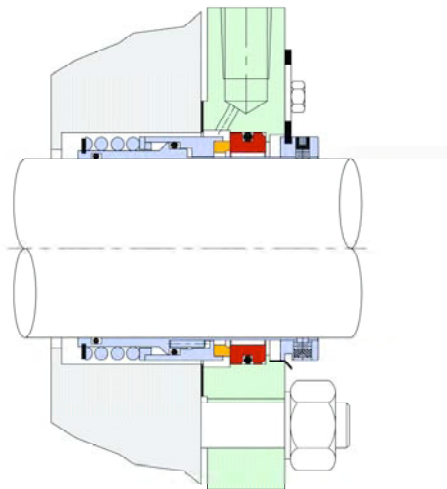

Metal Parts:

Standard metal parts and spring: 316 SS
Optional: Low expansion alloys (service over 400°F (205°C))

Face Materials:

Standard: High quality chemical grade carbon-graphite, solid nickel bound tungsten carbide, and silicon carbide

O-ring Materials:

Standard: Viton[®], EPR and Aflas[™]
Optional: Perfluorinated Elastomers

Operating Capabilities:

Pressure: To 350 psig (24 bar g)
Temperature (standard metal): -20° to 400°F (-29° to 205°C)
Temperature (low expansion alloys and perfluorinated elastomer o-rings): -40 to 550°F (-40 to 288°C)
Speeds: 5000 fpm (25 m/s)

SPECIAL DUTY SEALS - SINGLE CARTRIDGE

VSR - VERTICAL SINGLE ROTARY SEAL

The SEPCO® VSR is a single, external, cartridge-mounted, rotary seal designed for installations where shaft deflection exceeds the limits allowed by off-the-shelf cartridge seals. Excessive radial clearances designed in the seal make it ideal for vertical turbine pumps in power plants, pulp & paper mills, municipalities, and applications in relatively clean, lubricating fluids.

Cartridge Mounted

The VSR is a completely self contained unit that is pre-assembled and pre-set at the factory for ease of installation. This feature also allows impeller adjustments to be made quickly and easily without interfering with the correct axial setting of the seal.

Mounts Externally

This allows installation on equipment where packing has been used without having to replace expensive shafts and sleeves.

Hydraulically Balanced

Hydraulic balancing is achieved internally allowing operation in higher pressures without the need for special stepped sleeves and shafts. The balance feature also reduces hydraulic loads allowing for cooler operation and extended reliability.

Versatile Gland

The gland is vented to eliminate air entrapment and improve cooling efficiency for longer seal life. Machined glands offer superior corrosion resistance and strength and can be modified to fit the equipment saving equipment modification cost.

Fully Repairable

All sealing elements that wear during normal operation can be replaced and the seal repaired at a fraction of the cost of a new seal while providing performance consistent with a new seal.

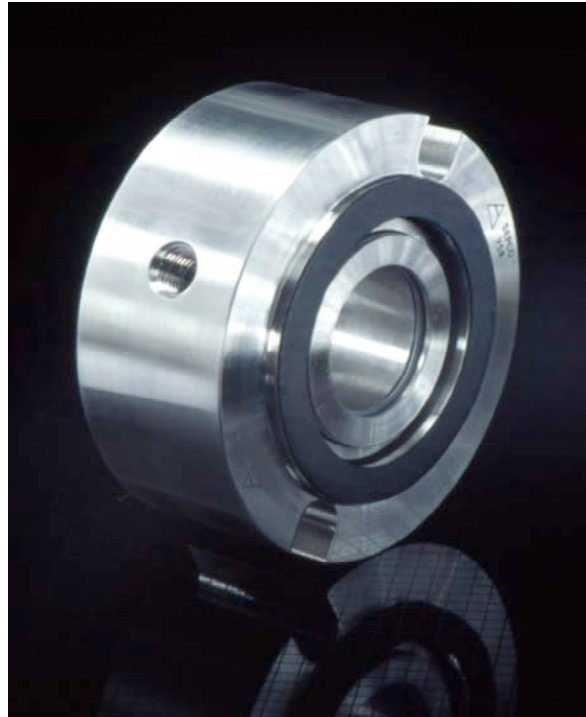

www.sepcoUSA.com

VSR - SPECIFICATIONS

Metal Parts:

Standard metal parts and set screws: 316 SS
Standard Springs and drive pins: Hastelloy® C

Face Materials:

Standard: High quality chemical grade carbon-graphite, solid nickel bound tungsten carbide, silicon carbide, and high purity ceramic
Optional: 17-4PH stainless steel.

O-ring Materials:

Standard: Viton®, EPR and Aflas™

Operating Capabilities:

Pressure: To 300 psig (21 bar g)
Temperature: 32° to 400°F (0° to 205°C)
Speeds: 5000 fpm (25 m/s)

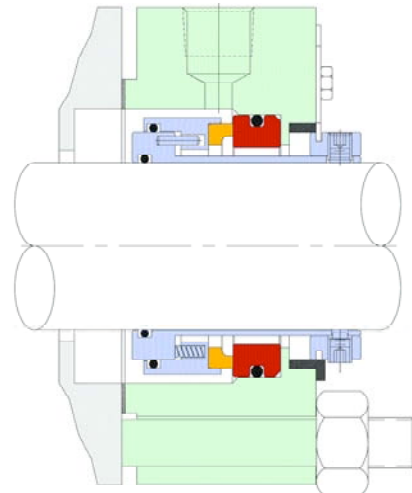

800-633-4770

SPECIAL DUTY SEALS - SINGLE CARTRIDGE

ESC - EXTERNAL SINGLE CARTRIDGE SEAL

The SEPCO® ESC is a single, external, cartridge-mounted unit designed for operation on clean, lubricating, fluids that are corrosive to standard 316SS parts. Alloy 20 wetted parts and a carbon-filled PTFE gland make this seal ideal for use in sulfuric acid. The stationary design eliminates face misalignment eliminating wear in secondary areas of the seal.

Cartridge Mounted

The unit is a completely self-contained design that is pre-assembled and pre-set at the factory for ease of installation and maintenance on equipment where axial adjustments are required.

Stationary Design

This design squares the faces 90° to the center-line of the shaft preventing misalignment allowing better control of the parallel sealing gap while eliminating axial adjustments that cause wear.

Hydraulically Balanced

Internal balancing reduces power consumption and provides for cooler operation in higher pressures extending seal reliability.

Isolated Multiple Springs

This provides even mechanical loads for cooler operation and are isolated to prevent clogging from process fluids.

Static Shaft O-Ring

The shaft o-ring is static and is not required to move axially to adjust for misalignment preventing fretting and eliminating the need to replace expensive shafts and sleeves.

Versatility

The seal gland is slotted to provide maximum interchangeability and the short external length will fit equipment with minimal first obstruction space.



ESC - SPECIFICATIONS

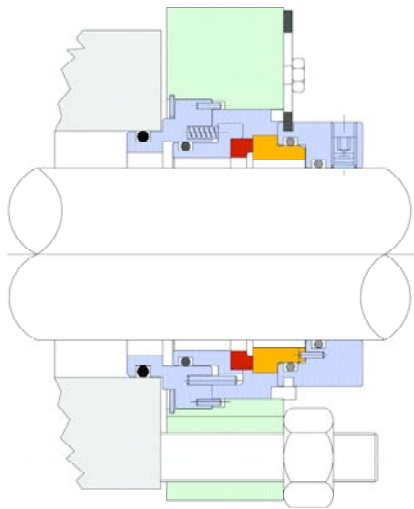

Metal Parts:

Standard parts: Alloy 20 wetted parts, carbon filled PTFE Gland
Standard springs and drive pins: Hastelloy® C

Face Materials:

Standard: Acid grade carbon-graphite, silicon carbide, and high purity ceramic

O-ring Materials:

Standard: Viton®, EPR and Aflas™
Optional: Litharge cured Viton® and Perfluorinated Elastomers

Operating Capabilities:

Pressure: To 150 psig (10 bar g)
Temperature: 32° to 250°F (0° to 121°C)
Speeds: 2600 fpm (13 m/s)

SPECIAL DUTY SEALS - DOUBLE CARTRIDGE

ESD - EXTERNALLY SET DOUBLE SEAL

The SEPCO® ESD is a back-to-back, multiple seal assembly designed for applications where positive lubrication is required from an external flush without dilution of product. Since all metal parts are isolated and the pumped product is sealed from the stuffing box, the ESD is an economic solution to sealing extremely corrosive and abrasive fluids.

Easily Installed

The ESD is a three-piece seal assembly that is pre-set and pre-assembled at the factory. Since it sets externally, mechanics are not required to make critical installation measurements.

Easily Maintained

Equipment disassembly is not required for axial adjustments.

Versatile

The ESD is designed for fitting small cross-section stuffing boxes. Its minimal internal length fits different stuffing box depths. These provisions are made internal to the seal preventing the need to make expensive equipment modifications.

Multiple Spring Design

This spring design provides even loading for cooler operation and reliability, are isolated from the pumped product to prevent clogging, and made of Hastelloy® C for superior corrosion resistance.

Product Isolated from Stuffing Box

The pumped product is sealed from the stuffing box reducing seal hang up while eliminating corrosive and erosive wear.

Economical & Repairable

Since all metal components are isolated from the pumped product, expensive alloys are not required. All normal wear components are easily replaced at a fraction of the cost of a new seal while gaining new seal performance.



ESD - SPECIFICATIONS

Metal Parts:

Standard isolated metal parts and set screws: 316 SS
Standard springs and drive pins: Hastelloy® C

Face Materials:

Inboard Standard: Silicon carbide
Outboard Standard: High quality chemical grade carbon-graphite, ceramic, and silicon carbide

O-ring Materials:

Standard: Viton®, EPR and Aflas™
Optional: Perfluorinated Elastomers

Operating Capabilities:

Pressure: 50 psig (3.4 bar g) Maximum Differential Pressure
75 psig (5.2 bar g) Maximum Discharge Pressure
Temperature: -20° to 250°F (-29° to 121°C)
Speeds: 5000 fpm (25 m/s)

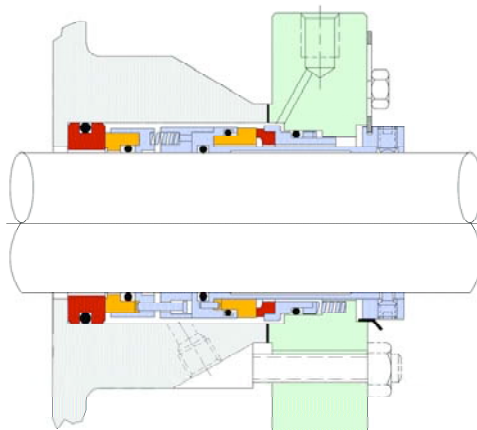

SPECIAL DUTY SEALS - DOUBLE CARTRIDGE

PRO - PROGRESSIVE CAVITY PUMP SEAL

The SEPCO® PRO is a multiple, cartridge-mounted, stationary seal designed for installation on progressive cavity pumps without having to make equipment modifications. The stationary design aligns the seal faces 90 degrees to the center-line of the shaft eliminating wear in secondary areas of the seal.

Stationary Design

This design squares the seal faces 90° to the centerline of the shaft preventing misalignment, giving better control of the parallel sealing gap and eliminating wear in secondary seal areas.

Cartridge Mounted

The PRO is a completely self-contained unit pre-assembled and pre-set at the factory for ease of installation and maintenance on equipment where axial adjustments may be required.

Versatile

The seal gland is slotted to provide versatility for mounting and machined for superior strength and corrosion resistance. The narrow cross-section inboard design allows for installation on stuffing boxes with minimal radial space.

Reciprocal Balanced

The inboard seal is balanced from both the product side as well as the flush side of the inboard seal faces. The seal can operate in either a tandem or double mode without face separation.

Multiple Springs

Multiple springs provide even mechanical loads for cooler operation and are isolated from the pumped product to prevent clogging. They are manufactured from Hastelloy® to provide superior corrosion resistance.

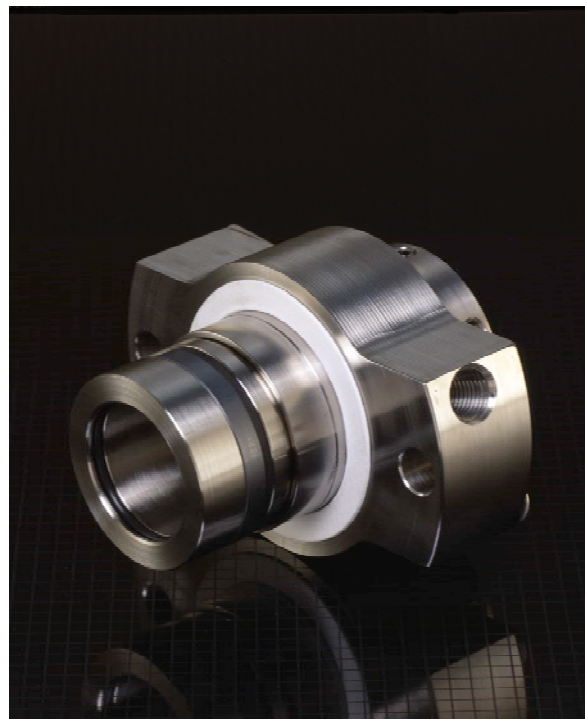

PRO - SPECIFICATIONS

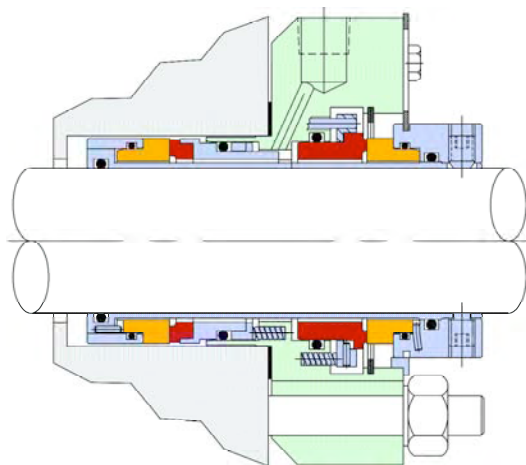

Metal Parts:

Standard metal parts and set screws: 316 SS
Springs: Hastelloy® C

Face Materials:

Standard: High quality chemical grade carbon-graphite, solid nickel bound tungsten carbide, ceramic, and silicon carbide

O-ring Materials:

Standard: Viton®, EPR and Aflas™
Optional: Perfluorinated Elastomers

Operating Capabilities:

Pressure: Inboard Seal: 350 psig (24 bar g) Pressure Differential
Outboard Seal: To 150 psig (10 bar g)
Temperature: Inboard Seal: To 400°F (205°C)
Outboard Seal: To 250°F (121°C)
Speeds: 7500 fpm (38 m/s)

SPECIAL DUTY SEALS - DOUBLE CARTRIDGE

DRC - DOUBLE ROTARY CARTRIDGE

The **DRC** is a multiple, cartridge mounted, rotary seal designed to be easily adapted on equipment that is difficult to fit. Although inexpensive, it is rugged and highly dependable. The unit is ideal for installation on positive displacement pumps moving abrasive, sticky products requiring multiple seals operating in conjunction with closed loop systems.

Cartridge Mounted

The DRC is a completely self-contained unit pre-assembled and pre-set at the factory for ease of installation.

Reciprocal Balanced

The inboard seal is hydraulically balanced to permit the seal to operate in either a double or tandem mode. This provides lubrication of the inboard seal faces without separation and leakage.

Clamped-In Mating Ring

Stationaries are clamped in allowing for higher pressure operation

Versatile

The gland is machined for superior strength and corrosion resistance. Machining allows for modifications within the seal instead of modifying the equipment. The narrow cross-section and short axial length allows use on equipment with limited space.

Multiple Springs

Multiple springs provide even mechanical loads for cooler operation and are isolated to prevent clogging.

Static Shaft O-Ring

The o-ring that seals to the shaft is static and not required to slide axially to adjust for seal face misalignment. This prevents wear and the need to replace expensive shafts.

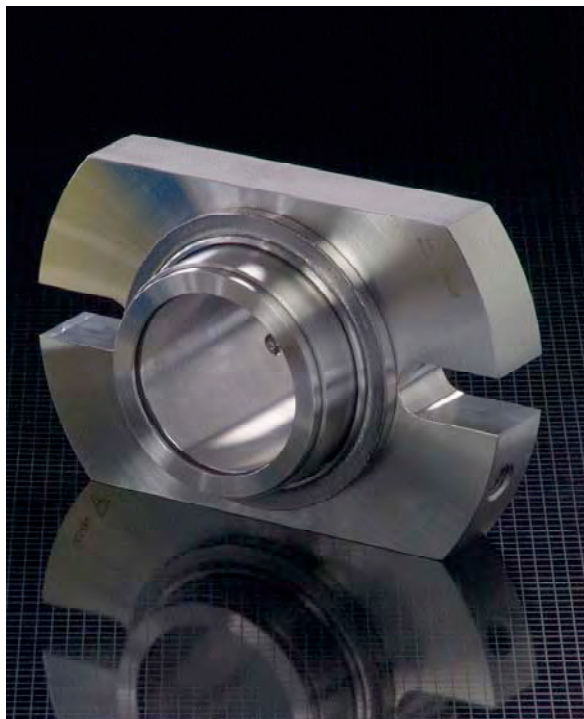

www.sepcoUSA.com

DRC - SPECIFICATIONS

Metal Parts:

Standard metal parts: 316 SS
Standard springs and drive pins: Hastelloy® C

Face Materials:

Standard: High quality chemical grade carbon-graphite and
17-4PH stainless Steel

O-ring Materials:

Standard: Viton®, EPR and Aflas™
Optional: Perfluorinated Elastomers

Operating Capabilities:

Pressure: Inboard Seal: 350 psig (24 bar g) Pressure Differential
Outboard Seal: To 150 psig (10 bar g)
Temperature: Inboard Seal: To 400°F (205°C)
Outboard Seal: To 250°F (121°C)
Speeds: 5000 fpm (25 m/s)

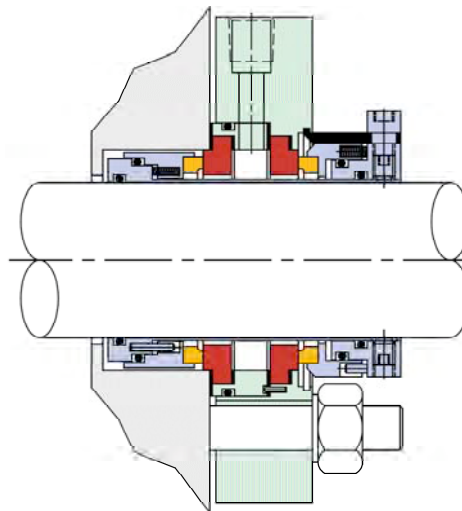

800-633-4770

SPECIAL DUTY SEALS - DOUBLE CARTRIDGE

RBA - RECIPROCAL BALANCED AXIAL SEAL

The SEPCO® RBA is a multiple, cartridge mounted seal. The flexible parts are mounted in the gland to reduce centrifugal forces permitting operation on high PV applications. The multiple spring design allows up to 1/16" end-play making the seal ideal for equipment with excessive end-play, split case pumps and where positive lubrication is required from an external source without diluting the pumped product.

Stationary Design

This design squares the seal faces 90° to the centerline of the shaft preventing misalignment, giving better control of the parallel sealing gap and eliminating wear in secondary seal areas.

Cartridge Mounted

The RBA is a completely self-contained unit pre-assembled and pre-set at the factory for ease of installation and maintenance.

Versatile

The seal gland is slotted to provide versatility for mounting and machined for superior strength and corrosion resistance. The narrow cross-section inboard design allows for installation on stuffing boxes with minimal radial space.

Reciprocal Balanced

The inboard seal is balanced from the product side as well as the flush side of the inboard seal faces. The RBA can operate in either a tandem or double mode without face separation.

Multiple Springs

Multiple springs provide even mechanical loads for cooler operation and are isolated from the pumped product to prevent clogging. They are manufactured from Hastelloy® to provide superior corrosion resistance.

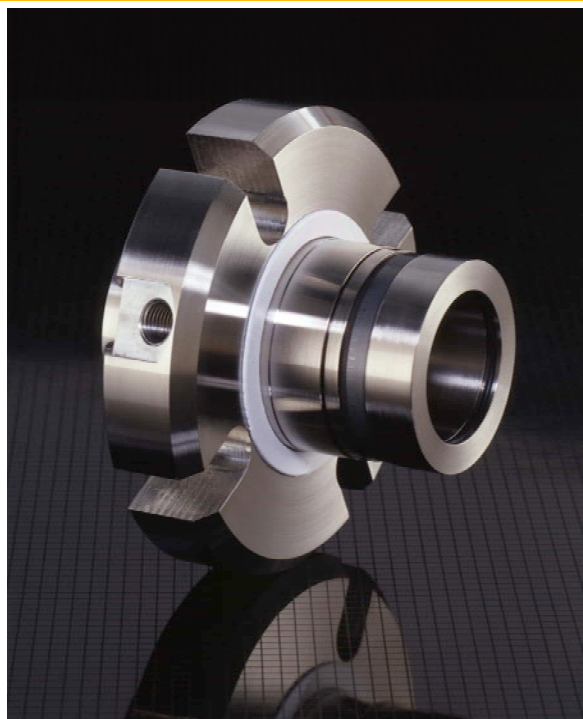

RBA - SPECIFICATIONS



Metal Parts:

Standard metal parts and set screws: 316 SS
Springs: Hastelloy® C

Face Materials:

Standard: High quality chemical grade carbon-graphite, solid nickel bound tungsten carbide, high-purity ceramic, and silicon carbide

O-ring Materials:

Standard: Viton®, EPR and Aflas™
Optional: Perfluorinated Elastomers

Operating Capabilities:

Pressure: Inboard Seal: 350 psig (24 bar g) Pressure Differential
Outboard Seal: To 150 psig (10 bar g)
Temperature: Inboard Seal: To 400°F (205°C)
Outboard Seal: To 250°F (121°C)
Speeds: 7500 fpm (38 m/s)

SPECIAL DUTY SEALS - DOUBLE CARTRIDGE

EDP - ETHANOL DOUBLE PUMPER

The **EDP** is a back-to-back, multiple seal assembly that was designed exclusively for sealing abrasive products where positive lubrication is required from an external source without dilution. The design isolates the metal components and prevents abrasive & corrosive pumped products from entering the stuffing box and causing erosion problems that require expensive repair.

Bi-Directional Radial Flow Pumping Ring

The pumping ring with tangentially drilled flush ports remove destructive heat from the seal cavity for cooler operation and extended reliability. The EDP is ideal in closed-loop flush systems.

Easily Installed

The EDP is a three-piece seal assembly that is pre-assembled and pre-set at the factory. Since the EDP sets externally, mechanics are not required to make critical installation measurements and can make axial adjustments with the equipment on-line.

Versatile

Provisions for fitting the seal are made internal to prevent the need to make expensive equipment modifications. Complete dimensional information is required to confirm fit specifications.

Isolated Multiple Springs

Multiple springs load evenly for cool operation and are isolated from the product to prevent clogging from suspended solids.

Economical & Repairable

Since the product is excluded from the stuffing box, the ESP is an economic alternative to replacement of expensive pump parts damaged by erosion. All sealing components that wear during normal operation can be easily replaced at a fraction of the cost of a new seal making performance of the repaired seal consistent to that of a new seal.



www.sepcoUSA.com

EDP - SPECIFICATIONS

Metal Parts:

Standard metal parts: 316 SS

Face Materials:

Standard: High quality chemical grade carbon-graphite and silicon carbide

O-ring Materials:

Standard: Viton®, EPR and Aflas™
Optional: Perfluorinated Elastomers

Operating Capabilities:

Pressure: 50 psig (3.5 bar g) Maximum Pressure Differential
75 psig (5 bar g) Maximum Pump Discharge Pressure

Temperature: To 250°F (121°C)

Speeds: 5000 fpm (25 m/s)

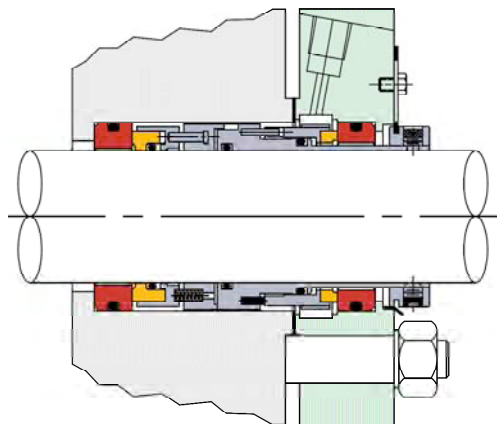

800-633-4770

SPECIAL DUTY SEALS - DOUBLE CARTRIDGE

OUS - OVER UNDER SEAL

The SEPCO® OUS mounts externally and is a multiple cartridge-mounted assembly for installation where first obstruction space is limited. It can handle up to 5/32" shaft deflection making it ideal for equipment where movement is excessive. The heavy duty design allows for successful operation where stuffing box pressure operates higher than safely handled by off-the-shelf designs.

Rotary or Stationary Design

The OUS is available in both rotary and stationary designs. The rotary is preferred on equipment with excessive shaft deflection and the stationary design where high PV factors are encountered.

Hydraulically Balanced

This allows for changes in operating pressures without face separation. Reduced hydraulic loads allow operation on high pressure without reducing lubrication critical for cooler operation.

Cartridge Mounted

A self-contained unit pre-assembled and pre-set at the factory eases installation and maintenance. When seal leakage occurs, the unique design allows the seal to be slid back and the stuffing box packed to control leakage until an outage can be scheduled.

Multiple Seal Design

Allows for installation where hazardous, abrasive, non-lubricating products are handled that require injection of a neutral liquid from an external source without diluting the pumped product. The seal can operate in either a double or tandem mode.

Isolated Multiple Springs

Multiple springs provide even mechanical loads for cooler operation and are isolated from the pumped product to eliminate clogging from suspended solids.

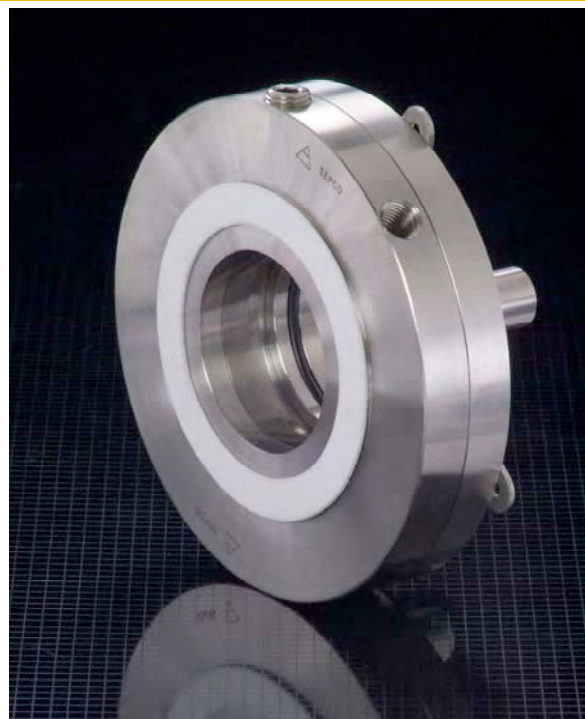

OUS - SPECIFICATIONS

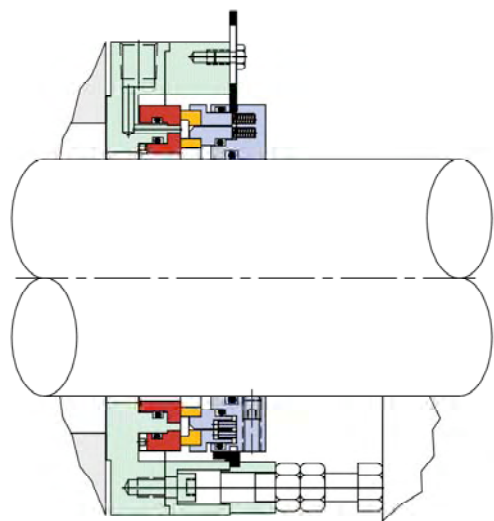

Metal Parts:

Standard metal parts: 316 SS

Face Materials:

Standard: High quality chemical grade carbon-graphite and solid nickel bound tungsten carbide
Optional: 17-4PH stainless steel.

O-ring Materials:

Standard: Viton®, EPR and Aflas™
Optional: Perfluorinated Elastomers

Operating Capabilities:

Pressure: To 750 psig (52 bar g)
Temperature: -20° to 500°F (-29° to 260°C)
Speeds: Rotary Design 5000 fpm (25 m/s)
Stationary Design 7500 fpm (38 m/s)

INSTALLATION DIMENSIONS - COMPONENT SEALS

CSO - CORROSIVE SERVICE OUTSIDE SEAL

Size Code	Shaft Diameter (A)		Seal OD (B)		Seal Face ID (C)		Seal Face OD (D)		Working Length (E)
	Inch	mm	Inch	mm	Inch	mm	Inch	mm	
M24		24	1.72	43.7	1.11	28.2	1.38	35.0	1-5/16
M25		25	1.76	44.7	1.15	29.2	1.42	36.1	1-5/16
16	1.00		1.78	45.2	1.16	29.5	1.44	36.6	1-5/16
M28		28	1.88	47.7	1.27	32.2	1.54	39.1	1-5/16
18	1-1/8		1.90	48.3	1.29	32.8	1.56	39.6	1-5/16
M30		30	1.96	49.8	1.35	34.3	1.62	41.1	1-5/16
20	1-1/4		2.03	51.6	1.41	35.8	1.70	43.2	1-5/16
M32		32	2.04	51.8	1.42	36.1	1.70	43.2	1-5/16
22	1-3/8		2.15	54.6	1.54	39.1	1.81	46.0	1-5/16
M35		35	2.15	54.6	1.54	39.1	1.81	46.0	1-5/16
M38		38	2.32	58.9	1.66	42.2	1.94	49.3	1-7/16
24	1-1/2		2.32	58.9	1.66	42.2	1.94	49.3	1-7/16
M40		40	2.39	60.7	1.74	44.2	2.02	51.3	1-7/16
26	1 5/8		2.44	62.0	1.79	45.5	2.06	52.3	1-7/16
28	1 3/4		2.57	65.3	1.91	48.5	2.19	55.6	1-7/16
M45		45	2.59	65.8	1.94	49.3	2.21	56.1	1-7/16
30	1 7/8		2.69	68.3	2.04	51.8	2.32	58.9	1-7/16
M50		50	2.79	70.9	2.13	54.1	2.41	61.2	1-7/16
32	2.00		2.82	71.6	2.16	54.9	2.44	62.0	1-7/16
34	2-1/8		2.94	74.7	2.29	58.2	2.57	65.3	1-7/16
M55		55	2.98	75.7	2.33	59.2	2.61	66.3	1-7/16
36	2-1/4		3.07	77.9	2.41	61.2	2.70	68.6	1-7/16
38	2-3/8		3.19	81.0	2.54	64.5	2.82	71.6	1-7/16
40	2-1/2		3.32	84.3	2.66	67.6	2.94	74.7	1-7/16
42	2-5/8		3.44	87.4	2.79	70.9	3.07	78.0	1-7/16

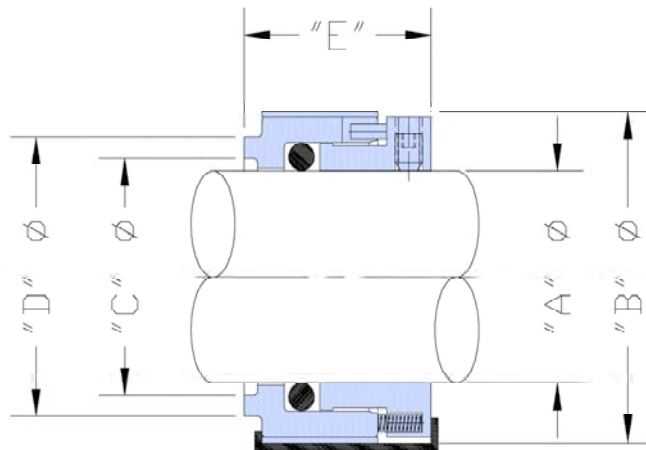

INSTALLATION DIMENSIONS - COMPONENT SEALS

HDN - HEAVY DUTY NARROW SEAL

Size Code	Shaft Diameter (A)		Seal OD (B)		Seal Face ID (C)		Seal Face OD (D)		Working Length (E)
	Inch	mm	Inch	mm	Inch	mm	Inch	mm	
M24		24	1.52	38.6	1.24	31.5	1.50	38.1	1-3/4
M25		25	1.58	40.1	1.31	33.3	1.56	39.6	1-3/4
16	1.00		1.58	40.1	1.31	33.3	1.56	39.6	1-3/4
M28		28	1.71	43.4	1.44	36.6	1.69	42.7	1-3/4
18	1-1/8		1.71	43.4	1.44	36.6	1.69	42.7	1-3/4
M30		30	1.77	44.9	1.50	38.1	1.74	44.2	1-3/4
20	1-1/4		1.85	47.0	1.56	39.6	1.81	46.0	1-3/4
M32		32	1.85	47.0	1.56	39.6	1.81	46.0	1-3/4
22	1-3/8		1.96	49.8	1.69	42.9	1.92	48.8	1-3/4
M35		35	1.96	49.8	1.69	42.9	1.92	48.8	1-3/4
M38		38	2.19	55.6	1.81	46.0	2.06	52.3	1-3/4
24	1-1/2		2.19	55.6	1.81	46.0	2.06	52.3	1-3/4
M40		40	2.26	57.4	1.88	47.7	2.15	54.6	1-3/4
26	1 5/8		2.31	58.7	1.93	49.0	2.19	55.6	1-3/4
28	1 3/4		2.44	62.0	2.05	52.1	2.32	58.9	1-3/4
M45		45	2.44	62.0	2.05	52.1	2.32	58.9	1-3/4
30	1 7/8		2.56	65.0	2.18	55.4	2.45	62.2	1-3/4
M50		50	2.69	68.3	2.31	58.7	2.57	65.3	1-3/4
32	2.00		2.69	68.3	2.31	58.7	2.57	65.3	1-3/4
34	2-1/8		2.81	71.4	2.43	61.7	2.70	68.6	1-3/4
M55		55	2.85	72.4	2.48	63.0	2.73	69.3	1-3/4
36	2-1/4		2.94	74.7	2.56	65.0	2.82	71.6	1-3/4
38	2-3/8		3.06	77.7	2.68	68.1	2.95	74.9	1-3/4
40	2-1/2		3.19	81.0	2.81	71.4	3.07	78.0	1-3/4
42	2-5/8		3.31	84.1	2.93	74.4	3.20	81.3	1-3/4

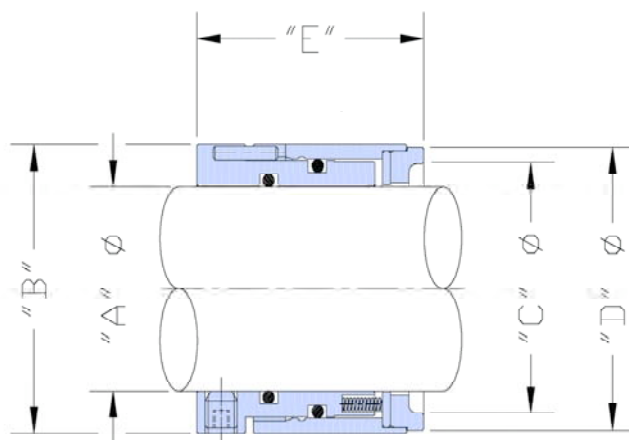

www.sepcoUSA.com

800-633-4770

INSTALLATION DIMENSIONS - COMPONENT SEALS

SRS - SHORT ROTARY SEAL

Size Code	Shaft Diameter (A)		Seal OD (B)		Seal Face ID (C)		Seal Face OD (D)		Minimum Box Bore	
	Inch	mm	Inch	mm	Inch	mm	Inch	mm	Inch	mm
M18		18	1.290	32.8	1.026	26.1	1.281	32.5	1.312	33.3
15	15/16		1.517	38.5	1.245	31.6	1.495	38.0	1.562	39.7
M24		24	1.517	38.5	1.245	31.6	1.495	38.0	1.562	39.7
M25		25	1.580	40.1	1.307	33.2	1.560	39.6	1.625	41.3
16	1.00		1.580	40.1	1.307	33.2	1.560	39.6	1.625	41.3
17	1-1/16		1.705	43.3	1.437	36.5	1.685	42.8	1.750	44.4
M28		28	1.705	43.3	1.437	36.5	1.685	42.8	1.750	44.4
18	1-1/8		1.705	43.3	1.437	36.5	1.685	42.8	1.750	44.4
M30		30	1.767	44.9	1.500	38.1	1.747	44.4	1.812	46.0
19	1-3/16		1.767	44.9	1.500	38.1	1.747	44.4	1.812	46.0
20	1-1/4		1.830	46.5	1.560	39.6	1.812	46.0	1.875	47.6
M32		32	1.830	46.5	1.560	39.6	1.812	46.0	1.875	47.6
21	1-5/16		1.955	49.6	1.690	42.9	1.917	48.7	2.000	50.8
22	1-3/8		1.955	49.6	1.690	42.9	1.917	48.7	2.000	50.8
23	1-7/16		2.017	51.2	1.752	44.5	1.997	50.7	2.187	55.5
24	1-1/2		2.080	52.8	1.747	44.4	2.004	50.9	2.125	54.0
M40		40	2.262	57.5	1.880	47.8	2.147	54.5	2.312	58.7
26	1 5/8		2.312	58.7	1.932	49.1	2.195	55.8	2.375	60.3
28	1 3/4		2.437	61.9	2.055	52.2	2.322	59.0	2.500	63.5
M45		45	2.437	61.9	2.055	52.2	2.322	59.0	2.500	63.5
30	1 7/8		2.562	65.1	2.181	55.4	2.448	62.2	2.625	66.7
M50		50	2.687	68.2	2.306	58.6	2.573	65.4	2.750	69.8
32	2.00		2.687	68.2	2.306	58.6	2.573	65.4	2.750	69.8
34	2-1/8		2.812	71.4	2.431	61.7	2.700	68.6	2.875	73.0
36	2-1/4		2.937	74.6	2.556	64.9	2.825	71.8	3.000	76.2
38	2-3/8		3.062	77.8	2.681	68.1	2.950	74.9	3.125	79.4
40	2-1/2		3.187	80.9	2.806	71.3	3.075	78.1	3.250	82.6
42	2-5/8		3.312	84.1	2.932	74.5	3.200	81.3	3.375	85.7

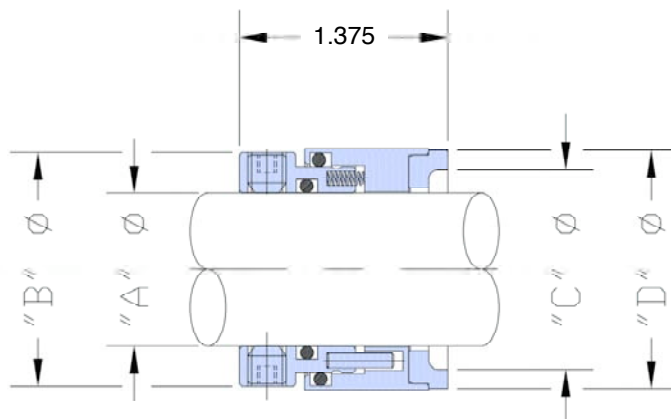

INSTALLATION DIMENSIONS - CARTRIDGE SEALS

BSS - BALANCED SINGLE SPRING SEAL

Size Code	Shaft Size (A)	Stuffing Box Bore (B)		Internal Length (C)	External Length (D)	Min. Depth (E)	Gland Bolt Circle (F)			
		Min.	Max.				3/8 Stud Min.	Gland OD Max. BC	1/2 Studs Min.	Slot Size
16	1	1.625	1.750	2.01	1.27	2.07	2-19/32	4	2-23/32	9/16
18	1-1/8	1.750	1.875	2.01	1.27	2.07	2-23/32	4	2-27/32	9/16
20	1-1/4	1.875	2.000	2.01	1.27	2.07	2-27/32	4	2-31/32	9/16
22	1-3/8	2.000	2.125	2.01	1.27	2.07	2-31/32	4	3-3/32	9/16
24	1-1/2	2.250	2.500	2.01	1.40	2.07	3-11/32	5	3-15/32	5/8
26	1-5/8	2.375	2.625	2.01	1.40	2.07	3-15/32	5	3-19/32	5/8
28	1-3/4	2.500	2.750	2.01	1.40	2.07	3-19/32	5-1/2	3-23/32	5/8
30	1-7/8	2.625	2.875	2.01	1.40	2.07	3-23/32	5-1/2	3-27/32	5/8
32	2	2.750	3.000	2.01	1.40	2.07	3-27/32	6	3-31/32	5/8
34	2-1/8	2.875	3.125	2.01	1.40	2.07	3-31/32	6	4-3/32	3/4
36	2-1/4	3.000	3.375	2.01	1.40	2.07	4-3/32	6-1/4	4-7/32	3/4
38	2-3/8	3.125	3.500	2.01	1.40	2.07	4-7/32	6-1/4	4-11/32	3/4
40	2-1/2	3.250	3.625	2.01	1.40	2.07	4-11/32	6-1/2	4-15/32	3/4
42	2-5/8	3.625	4.125	3.03	2.35	3.09	4-31/32	6-1/2	5-3/32	3/4
44	2-3/4	3.750	4.250	3.03	2.35	3.09	5-3/32	7	5-7/32	3/4
46	2-7/8	3.875	4.375	3.03	2.35	3.09	5-7/32	7	5-11/32	3/4
48	3	4.000	4.500	3.03	2.35	3.09	5-7/32	8	5-11/32	7/8
50	3-1/8	4.125	4.625	3.03	2.35	3.09	5-11/32	8	5-15/32	7/8
52	3-1/4	4.250	4.750	3.03	2.35	3.09	5-15/32	8	5-19/32	7/8
54	3-3/8	4.375	4.875	3.03	2.35	3.09	5-19/32	8	5-23/32	7/8
56	3-1/2	4.500	5.000	3.03	2.35	3.09	5-23/32	8-1/2	5-27/32	7/8
58	3-5/8	4.625	5.125	3.03	2.35	3.09	5-27/32	8-1/2	5-31/32	7/8
60	3-3/4	4.750	5.250	3.03	2.35	3.09	5-31/32	8-1/2	6-3/32	7/8
62	3-7/8	4.875	5.375	3.03	2.35	3.09	6-3/32	8-1/2	6-7/32	7/8
64	4	5.000	5.500	3.03	2.35	3.09	6-7/32	9	6-11/32	7/8

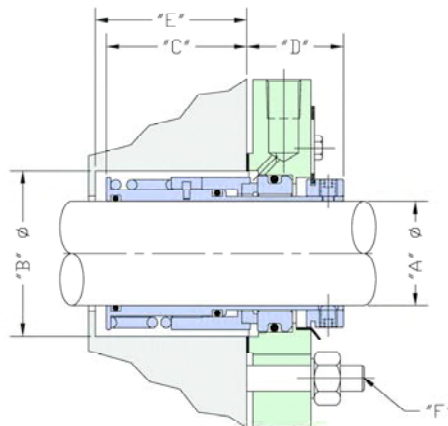

www.sepcoUSA.com

800-633-4770

INSTALLATION DIMENSIONS - CARTRIDGE SEALS

GEM - GENERAL SERVICE ECONOMICAL MODEL SEAL

Size Code	Shaft Size (A)	Stuffing Box Bore (B)		Internal Length (C)	External Length (D)	Min. Depth (E)	Gland Bolt Circle (F)			
		Min.	Max.				3/8 Stud Min.	Gland OD Max. BC	1/2 Studs Min.	Slot Size
18	1-1/8	1.750	2.125	.87	1.69	.93	2-25/32	4	2-29/32	5/8
22	1-3/8	2.000	2.375	.87	1.69	.93	3-1/32	4	3-5/32	5/8
28	1-3/4	2.500	2.750	.91	1.84	.97	3-19/32	5-1/2	3-23/32	5/8
30	1-7/8	2.625	3.000	.91	1.84	.97	3-23/32	5-1/2	3-27/32	5/8

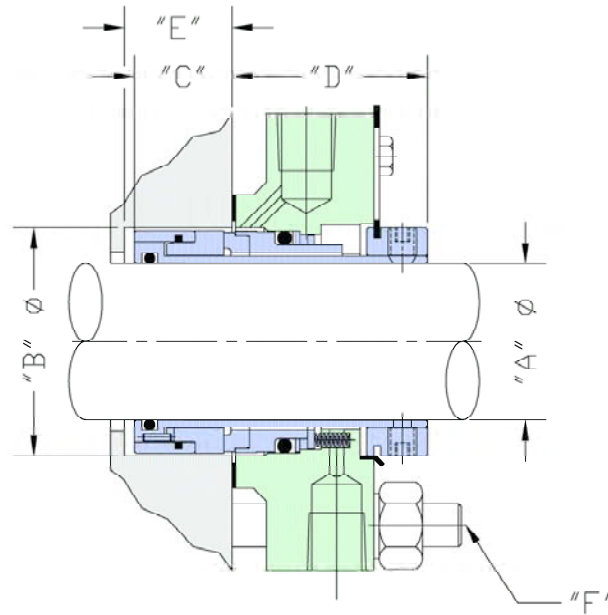

INSTALLATION DIMENSIONS - CARTRIDGE SEALS

HOS - HOT OIL SEAL

Size Code	Shaft Size (A)	Stuffing Box Bore (B)		Internal Length (C)	External Length (D)	Min. Depth (E)	Gland Bolt Circle (F)			
		Min.	Max.				3/8 Stud Min.	Gland OD Max. BC	1/2 Studs Min.	Slot Size
18	1-1/8	1.750	1.875	1.96	1.26	2.02	2-23/32	4	2-27/32	9/16
22	1-3/8	2.000	2.125	1.96	1.26	2.02	2-31/32	4	3-3/32	9/16
28	1-3/4	2.500	2.750	1.97	1.39	2.03	3-19/32	5-1/2	3-23/32	5/8
30	1-7/8	2.625	2.875	1.97	1.39	2.03	3-23/32	5-1/2	3-27/32	5/8
32	2	2.750	3.000	1.97	1.39	2.03	3-27/32	6	3-31/32	5/8
34	2-1/8	2.875	3.125	1.97	1.39	2.03	3-31/32	6	4-3/32	3/4
40	2-1/2	3.250	3.625	1.97	1.39	2.03	4-11/32	6-1/2	4-15/32	3/4
42	2-5/8	3.625	4.125	2.53	2.13	2.59	5	6-1/2	5-1/8	3/4
48	3	4.000	4.500	2.53	2.13	2.59	5-1/4	8	5-3/8	7/8
60	3-3/4	4.750	5.250	2.53	2.13	2.59	6	8-1/2	6-1/8	7/8
76	4-3/4	5.875	6.625	2.81	2.13	2.87	7-5/8	10-1/2	7-3/4	1

HOS - BIG BORE DIMENSIONS

22	1-3/8	2.875	3.125	1.85	1.38	1.91	4	4-3/4 x 3-3/4 Elliptical Gland	-	7/16
28	1-3/4	3.500	3.750	1.97	1.39	2.03	4-27/32	6-1/2	4-31/32	5/8
30	1-7/8	3.625	3.875	1.91	1.45	1.97	4-5/8	6	4-3/4	5/8
34	2-1/8	3.875	4.125	1.97	1.39	2.03	5-1/4	7	5-3/8	3/4
40	2-1/2	4.500	4.750	1.72	1.64	1.78	6	8	6-1/8	3/4
42	2-5/8	4.625	4.750	1.21	2.13	1.27	-	7	6	5/8 Holes

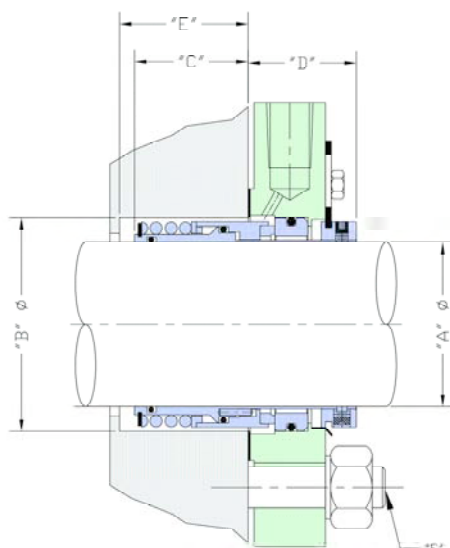

INSTALLATION DIMENSIONS - CARTRIDGE SEALS

SRC - SINGLE ROTARY CARTRIDGE SEAL

Size Code	Shaft Size (A)	Stuffing Box Bore (B)		Internal Length (C)	External Length (D)	Min. Depth (E)	Gland Bolt Circle (F)			
		Min.	Max.				3/8 Stud Min.	Gland OD Max. BC	1/2 Studs Min.	Slot Size
16	1	1.625	1.750	.92	1.26	.98	2-19/32	4	2-23/32	9/16
18	1-1/8	1.750	1.875	.92	1.26	.98	2-23/32	4	2-27/32	9/16
20	1-1/4	1.875	2.000	.92	1.26	.98	2-27/32	4	2-31/32	9/16
22	1-3/8	2.000	2.125	.92	1.26	.98	2-31/32	4	3-3/32	9/16
24	1-1/2	2.250	2.500	.95	1.39	1.01	3-11/32	5	3-15/32	5/8
26	1-5/8	2.375	2.625	.95	1.39	1.01	3-15/32	5	3-19/32	5/8
28	1-3/4	2.500	2.750	.95	1.39	1.01	3-19/32	5-1/2	3-23/32	5/8
30	1-7/8	2.625	2.875	.95	1.39	1.01	3-23/32	5-1/2	3-27/32	5/8
32	2	2.750	3.000	.95	1.39	1.01	3-27/32	6	3-31/32	5/8
34	2-1/8	2.875	3.125	.95	1.39	1.01	3-31/32	6	4-3/32	3/4
36	2-1/4	3.000	3.375	.95	1.39	1.01	4-3/32	6-1/4	4-7/32	3/4
38	2-3/8	3.125	3.500	.95	1.39	1.01	4-7/32	6-1/4	4-11/32	3/4
40	2-1/2	3.250	3.625	.95	1.39	1.01	4-11/32	6-1/2	4-15/32	3/4
42	2-5/8	3.625	4.125	.95	2.13	1.01	5	6-1/2	5-1/8	3/4
44	2-3/4	3.750	4.250	.95	2.13	1.01	5-1/8	7	5-1/4	3/4
46	2-7/8	3.875	4.375	.95	2.13	1.01	5-1/4	7	5-3/8	3/4
48	3	4.000	4.500	.95	2.13	1.01	5-1/4	8	5-3/8	7/8
50	3-1/8	4.125	4.625	.95	2.13	1.01	5-3/8	8	5-1/2	7/8
52	3-1/4	4.250	4.750	.95	2.13	1.01	5-1/2	8	5-5/8	7/8
54	3-3/8	4.375	4.875	.95	2.13	1.01	5-5/8	8	5-3/4	7/8
56	3-1/2	4.500	5.000	.95	2.13	1.01	5-3/4	8-1/2	5-7/8	7/8
58	3-5/8	4.625	5.125	.95	2.13	1.01	5-7/8	8-1/2	6	7/8
60	3-3/4	4.750	5.250	.95	2.13	1.01	6	8-1/2	6-1/8	7/8
62	3-7/8	4.875	5.375	.95	2.13	1.01	6-1/8	8-1/2	6-1/4	7/8
64	4	5.000	5.500	.95	2.13	1.01	6-1/4	9	6-3/8	7/8
68	4-1/4	5.250	6.125	.95	2.13	1.01	7	9-1/2	7-1/8	7/8
72	4-1/2	5.500	6.375	.95	2.13	1.01	7-3/16	10	7-5/16	7/8
76	4-3/4	5.750	6.625	.95	2.13	1.01	7-5/8	10-1/2	7-3/4	1
80	5	6.250	7.375	.95	2.13	1.01	8-3/16	10-1/2	8-5/16	1

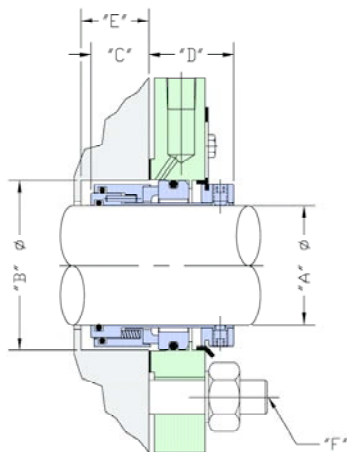

INSTALLATION DIMENSIONS - CARTRIDGE SEALS

VGS - VERSATILE GENERAL SERVICE SEAL

Size Code	Shaft Size (A)	Stuffing Box Bore (B)		Internal Length (C)	External Length (D)	Min. Depth (E)	Gland Bolt Circle (F)			
		Min.	Max.				3/8 Stud Min.	Gland OD Max. BC	1/2 Studs Min.	Slot Size
16	1	1.625	2.000	.85	1.71	.91	2-21/32	4	2-25/32	5/8
18	1-1/8	1.750	2.125	.85	1.71	.91	2-25/32	4	2-29/32	5/8
20	1-1/4	1.875	2.250	.85	1.71	.91	2-29/32	4	3-1/32	5/8
22	1-3/8	2.000	2.375	.85	1.71	.91	3-1/32	4	3-5/32	5/8
24	1-1/2	2.250	2.500	.91	1.84	.97	3-9/32	4-1/2	3-13/32	5/8
26	1-5/8	2.375	2.625	.91	1.84	.97	3-13/32	5	3-17/32	5/8
28	1-3/4	2.500	2.750	.91	1.84	.97	3-19/32	5-1/2	3-23/32	5/8
30	1-7/8	2.625	3.000	.91	1.84	.97	3-23/32	5-1/2	3-27/32	5/8
32	2	2.750	3.125	.79	1.96	.85	3-25/32	5	3-29/32	5/8
34	2-1/8	2.875	3.125	.79	1.96	.85	3-27/32	6	3-31/32	3/4
36	2-1/4	3.000	3.750	.79	1.96	.85	4-15/32	6	4-19/32	3/4
38	2-3/8	3.125	3.875	.79	1.96	.85	4-19/32	6	4-23/32	3/4
40	2-1/2	3.250	4.000	.79	1.96	.85	4-23/32	6	4-27/32	3/4
42	2-5/8	3.625	4.125	.79	1.96	.85	4-27/32	6	4-31/32	3/4
44	2-3/4	3.750	4.250	1.11	2.30	1.17	4-31/32	7	5-3/32	3/4
46	2-7/8	3.875	4.375	1.11	2.30	1.17	5-3/32	7	5-7/32	3/4
48	3	4.000	4.500	1.11	2.30	1.17	5-7/32	8	5-11/32	7/8
50	3-1/8	4.125	4.625	1.11	2.30	1.17	5-11/32	8	5-15/32	7/8
52	3-1/4	4.250	5.125	1.11	2.30	1.17	5-27/32	8	5-31/32	7/8
54	3-3/8	4.375	5.250	1.11	2.30	1.17	5-31/32	8	6-3/32	7/8
56	3-1/2	4.500	5.375	1.11	2.30	1.17	6-3/32	8-1/2	6-7/32	7/8
58	3-5/8	4.625	5.500	1.11	2.30	1.17	6-7/32	8-1/2	6-11/32	7/8
60	3-3/4	4.750	5.625	1.11	2.30	1.17	6-11/32	8-1/2	6-15/32	7/8
62	3-7/8	4.875	5.750	1.11	2.30	1.17	6-15/32	8-1/2	6-19/32	7/8
64	4	5.000	6.000	1.11	2.30	1.17	6-23/32	9	6-27/32	7/8
68	4-1/4	5.250	6.125	1.11	2.30	1.17	6-31/32	9-1/2	7-3/32	7/8
72	4-1/2	5.500	6.375	1.11	2.30	1.17	7-7/32	10	7-11/32	7/8
76	4-3/4	5.750	6.625	1.11	2.30	1.17	7-9/16	10-1/2	7-11/16	1
80	5	6.250	7.375	1.08	2.48	1.14	8-3/16	10-1/2	8-5/16	1
84	5-1/4	6.500	7.625	1.08	2.48	1.14	8-7/16	11-1/2	8-9/16	1
88	5-1/2	6.750	7.875	1.08	2.48	1.14	8-11/16	11-1/2	8-13/16	1
92	5-3/4	7.000	8.125	1.08	2.48	1.14	8-15/16	12	9-1/16	1
96	6	7.250	8.875	1.08	2.48	1.14	9-11/16	12	9-13/16	1

www.sepcoUSA.com

800-633-4770

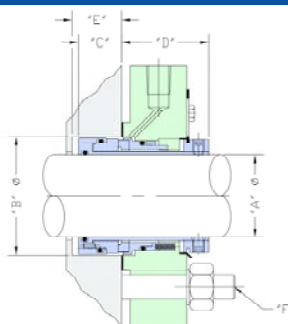

INSTALLATION DIMENSIONS - CARTRIDGE SEALS

DTP - DOUBLE TANDEM PUMPER SEAL

Size Code	Shaft Size (A)	Stuffing Box Bore (B)		Internal Length (C)	External Length (D)	Min. Depth (E)	Gland Bolt Circle (F)			
		Min.	Max.				3/8 Stud Min.	Gland OD Max. BC	1/2 Studs Min.	Slot Size
16	1	1.625	1.750	1.14	2.05	1.20	2-5/8	4		7/16
18	1-1/8	1.750	1.875	1.14	2.05	1.20	2-3/4	4		7/16
20	1-1/4	1.875	2.000	1.14	2.05	1.20	2-7/8	4		7/16
22	1-3/8	2.000	2.125	1.14	2.05	1.20	3	4-1/4		7/16
24	1-1/2	2.250	2.375	1.15	2.16	1.21	3-3/8	4-1/2	3-1/2	5/8
26	1-5/8	2.375	2.500	1.15	2.16	1.21	3-1/2	5	3-5/8	5/8
28	1-3/4	2.500	2.625	1.15	2.16	1.21	3-5/8	5-1/2	3-3/4	5/8
30	1-7/8	2.625	2.750	1.15	2.16	1.21	3-3/4	5-1/2	3-7/8	5/8
32	2	2.750	2.875	1.15	2.16	1.21	3-7/8	5-1/2	4	5/8
34	2-1/8	2.875	3.000	1.15	2.16	1.21	4	6	4-1/8	3/4
36	2-1/4	3.000	3.125	1.15	2.16	1.21	4-1/8	6	4-1/4	3/4
38	2-3/8	3.125	3.250	1.15	2.16	1.21	4-1/4	6	4-3/8	3/4
40	2-1/2	3.250	3.375	1.15	2.16	1.21	4-3/8	6	4-1/2	3/4
42	2-5/8	3.375	3.500	1.15	2.16	1.21	4-1/2	6	4-5/8	3/4
44	2-3/4	3.750	4.000	1.27	2.73	1.33	5-1/4	7	5-3/8	3/4
46	2-7/8	3.875	4.125	1.27	2.73	1.33	5-3/8	7	5-1/2	3/4
48	3	4.000	4.250	1.27	2.73	1.33	5-1/2	8	5-5/8	7/8
50	3-1/8	4.125	4.375	1.27	2.73	1.33	5-5/8	8	5-3/4	7/8
52	3-1/4	4.250	4.500	1.27	2.73	1.33	5-3/4	8	5-7/8	7/8
54	3-3/8	4.375	4.625	1.27	2.73	1.33	5-7/8	8	6	7/8
56	3-1/2	4.500	4.750	1.27	2.73	1.33	6	8-1/2	6-1/8	7/8
58	3-5/8	4.625	4.875	1.27	2.73	1.33	6-1/8	8-1/2	6-1/4	7/8
60	3-3/4	4.750	5.000	1.27	2.73	1.33	6-1/4	8-1/2	6-3/8	7/8
62	3-7/8	4.875	5.125	1.27	2.73	1.33	6-3/8	8-1/2	6-1/2	7/8
64	4	5.000	5.250	1.27	2.73	1.33	6-1/2	9	6-5/8	7/8
68	4-1/4	5.250	5.500	1.27	2.73	1.33	7	9-1/2	7-1/8	7/8
72	4-1/2	5.500	5.750	1.27	2.73	1.33	7-1/4	10	7-3/8	7/8
76	4-3/4	5.750	6.000	1.27	2.73	1.33	7-1/2	10-1/2	7-5/8	1
80	5	6.000	6.250	1.27	2.73	1.33	8-1/4	10-1/2	8-3/8	1

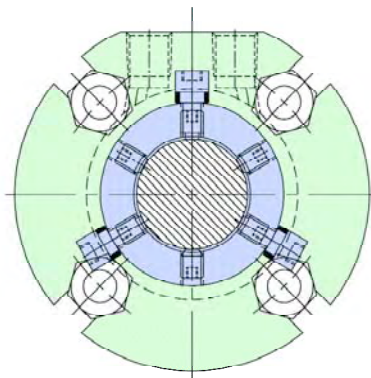
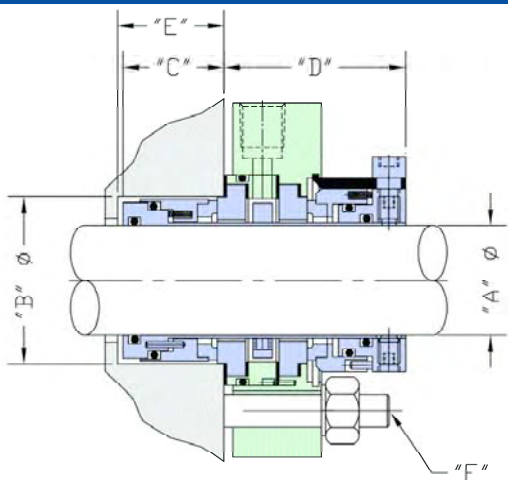

INSTALLATION DIMENSIONS - CARTRIDGE SEALS

RBD - RECIPROCALLY BALANCED DOUBLE SEAL

Size Code	Shaft Size (A)	Stuffing Box Bore (B)		Internal Length (C)	External Length (D)	Min. Depth (E)	Gland Bolt Circle (F)			
		Min.	Max.				3/8 Stud Min.	Gland OD Max. BC	1/2 Studs Min.	Slot Size
16	1	1.625	2.000	1.74	2.01	1.80	2-11/16	4	2-13/16	5/8
18	1-1/8	1.750	2.125	1.74	2.01	1.80	2-13/16	4-1/4	2-15/16	5/8
20	1-1/4	1.875	2.250	1.74	2.01	1.80	2-15/16	4-1/4	3-1/16	5/8
22	1-3/8	2.000	2.375	1.72	2.03	1.78	3-1/8	4-1/4	3-1/4	5/8
24	1-1/2	2.250	2.500	1.99	2.07	2.05	3-5/16	4-1/2	3-7/16	5/8
26	1-5/8	2.375	2.625	1.99	2.07	2.05	3-15/32	5	3-19/32	5/8
28	1-3/4	2.500	2.750	1.99	2.07	2.05	3-5/8	5-1/2	3-3/4	5/8
30	1-7/8	2.625	3.000	1.74	2.32	1.80	3-23/32	5-1/2	3-27/32	5/8
32	2	2.750	3.125	1.99	2.07	2.05	3-13/16	5	3-15/16	5/8
34	2-1/8	2.875	3.125	1.74	2.32	1.80	3-31/32	6	4-3/32	3/4
36	2-1/4	3.000	3.750	1.74	2.32	1.80	4-15/32	6	4-19/32	3/4
38	2-3/8	3.125	3.875	1.74	2.32	1.80	4-19/32	6	4-23/32	3/4
40	2-1/2	3.250	4.000	1.99	2.07	2.05	4-11/16	6	4-13/16	3/4
42	2-5/8	3.625	4.125	2.25	2.84	2.31	4-13/16	6	4-15/16	3/4
44	2-3/4	3.750	4.250	2.25	2.84	2.31	4-31/32	7	5-3/32	3/4
46	2-7/8	3.875	4.375	2.25	2.84	2.31	5-1/16	7	5-3/16	3/4
48	3	4.000	4.500	2.25	2.84	2.31	5-3/16	8	5-5/16	7/8
50	3-1/8	4.125	4.625	2.25	2.84	2.31	5-5/16	8	5-7/16	7/8
52	3-1/4	4.250	5.125	2.25	2.84	2.31	5-13/16	8	5-15/16	7/8
54	3-3/8	4.375	5.250	2.25	2.84	2.31	5-15/16	8	6-1/16	7/8
56	3-1/2	4.500	5.375	2.25	2.84	2.31	6-1/16	8-1/2	6-3/16	7/8
58	3-5/8	4.625	5.500	2.25	2.84	2.31	6-3/16	8-1/2	6-5/16	7/8
60	3-3/4	4.750	5.625	2.25	2.84	2.31	6-5/16	8-1/2	6-7/16	7/8
62	3-7/8	4.875	5.750	2.34	2.75	2.40	6-7/16	8-1/2	6-9/16	7/8
64	4	5.000	6.000	2.25	2.84	2.31	6-11/16	9	6-13/16	7/8
68	4-1/4	5.250	6.125	2.25	2.84	2.31	6-15/16	9-1/2	7-1/16	7/8
72	4-1/2	5.500	6.375	2.25	2.84	2.31	7-3/16	10	7-5/16	7/8
76	4-3/4	5.750	6.625	2.25	2.84	2.31	7-7/16	10-1/2	7-9/16	1
80	5	6.250	7.375	2.25	2.84	2.31	8-3/16	10-1/2	8-5/16	1
84	5-1/4	6.500	7.625	2.25	2.84	2.31	8-7/16	11-1/2	8/9/16	1
88	5-1/2	6.750	7.875	2.25	2.84	2.31	8-11/16	11-1/2	8-13/16	1
92	5-3/4	7.000	8.125	2.25	2.84	2.31	8-15/16	12	9/1/16	1
96	6	7.250	8.875	2.25	2.84	2.31	9-11/16	12	9/13/16	1

www.sepcoUSA.com

800-633-4770

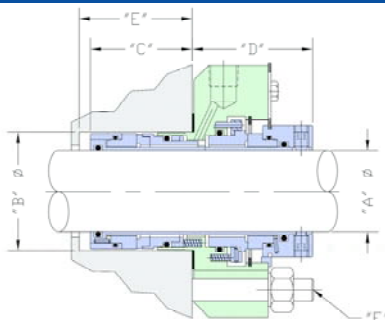

INSTALLATION DIMENSIONS - CARTRIDGE SEALS

SRC - BIG BORE DIMENSIONS

Size Code	Shaft Size (A)	Stuffing Box Bore (B)		Internal Length (C)	External Length (D)	Min. Depth (E)	Gland Bolt Circle (F)			
		Min.	Max.				3/8 Stud Min.	Gland OD Max. BC	1/2 Studs Min.	Slot Size
22	1-3/8	2.875	3.125	.81	1.38	.87	4	4-3/4 x 3-3/4 Elliptical Gland		7/16
28	1-3/4	3.500	3.750	.95	1.39	1.01	4-27/32	6-1/2	4-31/32	5/8
30	1-7/8	3.625	3.875	.89	1.45	.95	4-5/8	6	4-3/4	5/8
34	2-1/8	3.875	4.125	.95	1.39	1.01	5-1/4	7	5-3/8	3/4
40	2-1/2	4.500	4.750	.70	1.64	.76	6	8	6-1/8	3/4
42	2-5/8	4.625	4.750	.92	2.15	.98	-	7	6	5/8 Holes

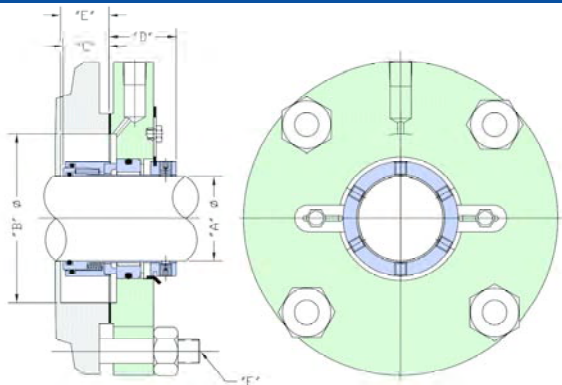

DTP - BIG BORE DIMENSIONS

Size Code	Shaft Size (A)	Stuffing Box Bore (B)		Internal Length (C)	External Length (D)	Min. Depth (E)	Gland Bolt Circle (F)			
		Min.	Max.				3/8 Stud Min.	Gland OD Max. BC	1/2 Studs Min.	Slot Size
22	1-3/8	2.875	3.000	1.14	2.05	1.20	4	4-3/4 x 3-3/4 Elliptical Gland		7/16
28	1-3/4	3.500	3.625	1.15	2.16	1.21	4-5/8	6	4-3/4	5/8
30	1-7/8	3.625	3.750	1.15	2.16	1.21	4-11/16	5-1/2	4-13/16	5/8
34	2-1/8	3.875	4.125	1.15	2.16	1.21	5-1/8	7	5-1/4	11/16
40	2-1/2	4.500	4.750	1.15	2.16	1.21	5-3/4	7-1/2	5-7/8	11/16
42	2-5/8	4.625	4.750	1.15	2.16	1.21	5-3/4	7-1/2	5-7/8	11/16

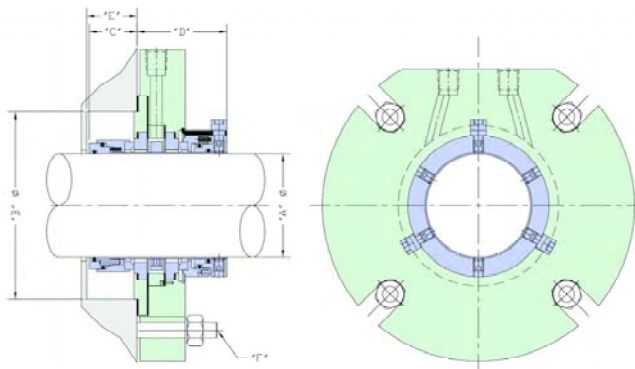

STATIONARY SEAT DIMENSIONS

www.sepcoUSA.com

O-Ring Mount						O-Ring Mount					
Seal Size		OD (A)	Bore ID (B)	ID (C)	Hgt. (D)	Seal Size		OD (A)	Bore ID (B)	ID (C)	Hgt. (D)
Inch	Dash #					Inch	Dash #				
15/16	7.5	1.551	1.562	1.000	.375	2-1/2	20	3.364	3.375	2.574	.562
1	8	1.614	1.625	1.062	.437	2-5/8	21	3.487	3.500	2.702	.625
1-1/8	9	1.739	1.750	1.187	.437	2-3/4	22	3.737	3.750	2.952	.625
1-1/4	10	1.864	1.875	1.312	.437	2-7/8	23	3.862	3.875	3.077	.625
1-3/8	11	1.989	2.000	1.437	.437	3	24	3.987	4.000	3.202	.625
1-1/2	12	2.114	2.125	1.562	.437	3-1/8	25	4.112	4.125	3.327	.625
1-5/8	13	2.364	2.375	1.687	.500	3-1/4	26	4.237	4.250	3.452	.625
1-3/4	14	2.489	2.500	1.812	.500	3-3/8	27	4.362	4.375	3.577	.625
1-7/8	15	2.614	2.625	1.937	.500	3-1/2	28	4.487	4.500	3.702	.687
2	16	2.739	2.750	2.062	.500	3-5/8	29	4.612	4.625	3.827	.687
2-1/8	17	2.864	2.875	2.187	.562	3-3/4	30	4.737	4.750	3.952	.687
2-1/4	18	3.114	3.125	2.312	.562	3-7/8	31	4.862	4.875	4.077	.687
2-3/8	19	3.239	3.250	2.437	.562	4	32	4.987	5	4.202	.687



O-Ring Mounted



T-Shape Standard

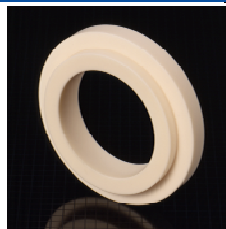

L-Shape

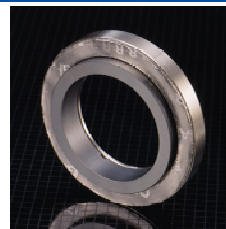

RF Mount



T-Shape OEM

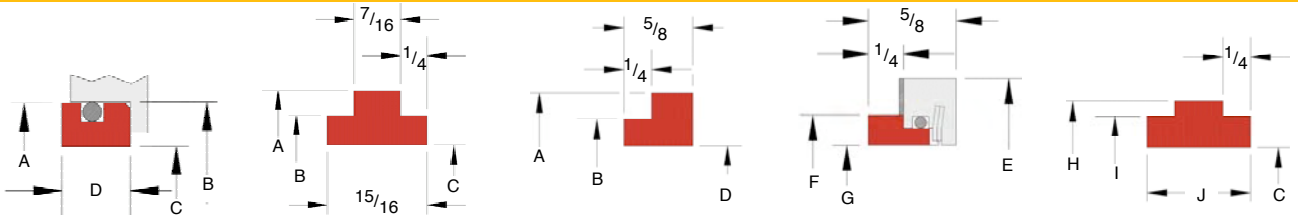

Seal Size		Standard T-Shape			L-Shape	RF Mount			OEM T-Shape		
Inch	Dash #	OD (A)	Face OD (B)	ID (C)	ID (D)	OD (E)	OD (F)	ID (G)	OD (H)	Face OD (I)	Thk. (J)
15/16	7.5	1.93	1.55	1.00	1.06	-	-	-	-	-	-
1	8	2.09	1.62	1.06	1.12	2.09	1.575	1.135	-	-	-
1-1/8	9	2.21	1.74	1.19	1.25	2.22	1.700	1.260	1.980	1.745	1.000
1-3/16	9.5	2.43	1.80	1.25	1.31	-	-	-	-	-	-
1-1/4	10	2.34	1.87	1.31	1.37	2.34	1.825	1.395	2.375	1.995	0.875
1-3/8	11	2.35	1.99	1.43	1.50	2.41	1.950	1.510	2.350	1.995	1.000
1-1/2	12	2.71	2.24	1.56	1.62	2.72	2.135	1.635	-	-	-
1-5/8	13	2.84	2.37	1.69	1.75	2.84	2.288	1.788	-	-	-
1-3/4	14	3.09	2.49	1.81	1.87	3.09	2.406	1.906	2.975	2.495	1.000
1-7/8	15	3.21	2.61	1.93	2.00	3.22	2.525	2.025	2.855	2.620	1.000
2	16	3.40	2.74	2.06	2.12	3.47	2.635	2.135	-	-	-
2-1/8	17	3.71	2.86	2.20	2.25	3.72	2.800	2.300	-	-	-
2-1/4	18	3.84	2.99	2.32	2.37	3.84	2.918	2.418	-	-	-
2-3/8	19	3.87	3.05	2.45	2.50	3.88	3.010	2.510	-	-	-
2-1/2	20	4.09	3.24	2.57	2.62	4.10	3.135	2.635	-	-	-
2-5/8	21	4.21	3.36	2.70	2.75	4.22	3.260	2.760	-	-	-

800-633-4770



Sealing Equipment Products Co., Inc.

123 Airpark Industrial Road • Alabaster, AL 35007

(205) 403-7500 • Toll Free: (800) 633-4770

Fax: (205) 403-7592 • Toll Free Fax: (800)-426-3592

Email: sales@sepcoUSA.com • Web site: www.sepcoUSA.com